

**DEWALT**®

**XR**®

**WWW.DEWALT.COM**

**DCB1104**



Fig. A

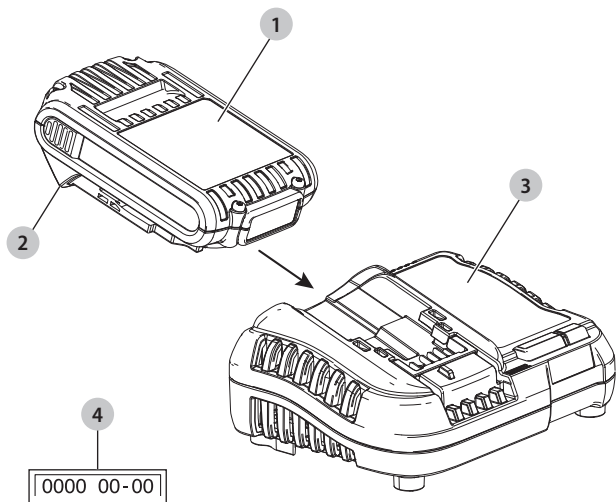

# BATTERY CHARGER

## DCB1104

### Congratulations!

You have chosen a DEWALT tool. Years of experience, thorough product development and innovation make DEWALT one of the most reliable partners for professional power tool users.

### Technical Data

		DCB1104
Output	$V_{DC}$	10.8, 12, 18
Mains voltage	$V_{AC}$	230
Type		1
Battery type		Li-Ion
Charger current		
Input	A	1
Output	A	4
Weight (without battery pack)	kg	0.5



**WARNING:** To reduce the risk of injury, read the instruction manual.

### Definitions: Safety Guidelines

The definitions below describe the level of severity for each signal word. Please read the manual and pay attention to these symbols.



**DANGER:** Indicates an imminently hazardous situation which, if not avoided, **will** result in **death or serious injury**.



**WARNING:** Indicates a potentially hazardous situation which, if not avoided, **could** result in **death or serious injury**.



**CAUTION:** Indicates a potentially hazardous situation which, if not avoided, **may** result in **minor or moderate injury**.

**NOTICE:** Indicates a practice **not related to personal injury** which, if not avoided, **may** result in **property damage**.



Denotes risk of electric shock.



Denotes risk of fire.

Batteries				DCB1104**
Cat #	V <sub>DC</sub>	Ah	Weight (kg)	Chargers/Charge Times (Minutes)
DCB546	18/54	6.0/2.0	1.08	90
DCB547	18/54	9.0/3.0	1.46	135*
DCB548	18/54	12.0/4.0	1.46	180
DCB549	18/54	15.0/5.0	2.12	230
DCB181	18	1.5	0.35	22
DCB182	18	4.0	0.61	60
DCB183/B/G	18	2.0	0.40	30
DCB184/B/G	18	5.0	0.62	75
DCB185	18	1.3	0.35	22
DCB187	18	3.0	0.54	45
DCB189	18	4.0	0.54	60
DCBP034	18	1.7	0.32	27

\*Date code 201811475B or later

\*\*Battery charge times matrix provided for guidance only; charge times will vary depending on temperature and condition of batteries.

## SAVE ALL WARNINGS AND INSTRUCTIONS FOR FUTURE REFERENCE

### Important Safety Instructions for All Battery Chargers

- Before using charger, read all instructions and cautionary markings on charger, battery pack, and product using battery pack.



**WARNING:** Shock hazard. Do not allow any liquid to get inside charger. Electric shock may result.



**CAUTION:** Burn hazard. To reduce the risk of injury, charge only DEWALT rechargeable batteries. Other

types of batteries may burst causing personal injury and damage.

**NOTICE:** Under certain conditions, with the charger plugged into the power supply, the exposed charging contacts inside the charger can be shorted by foreign material. Foreign materials of a conductive nature such as, but not limited to, steel wool, aluminum foil or any buildup of metallic particles should be kept away from charger cavities. Always unplug the charger from the power supply when there is no battery pack in the cavity. Unplug charger before attempting to clean.

- **Children are not allowed to use or play with this charger.** This charger can be used by persons with reduced physical, sensory or mental capabilities or lack of experience and knowledge if they have been given supervision or instruction concerning use of the appliance in a safe way and understand the hazards involved. Otherwise, there is a risk of injuries.
- **Children shall be supervised during cleaning to ensure that they do not play with the appliance.**
- **To reduce the risk of injury, charge only DEWALT rechargeable batteries.** Other types of batteries may burst causing personal injury and damage.
- **DO NOT attempt to charge the battery pack with any chargers other than the ones in this manual.**

---

*The charger and battery pack are specifically designed to work together.*

- ***These chargers are not intended for any uses other than charging DEWALT rechargeable batteries.***  
*Any other uses may result in risk of fire, electrical shock or electrocution.*
- ***Do not expose charger to rain or snow.***
- ***Pull by plug rather than cord when disconnecting charger.*** *This will reduce risk of damage to electric plug and cord*
- ***Make sure that cord is located so that it will not be stepped on, tripped over, or otherwise subjected to damage or stress.***
- ***Do not use an extension cord unless it is absolutely necessary.*** *Use of improper extension cord could result in risk of fire, electric shock, or electrocution.*
- ***Do not place any object on top of charger or place the charger on a soft surface that might block the ventilation slots and result in excessive internal heat.***  
*Place the charger in a position away from any heat source. The charger is ventilated through slots in the top and the bottom of the housing.*
- ***Do not operate charger with damaged cord or plug — have them replaced immediately.***

- **Do not operate charger if it has received a sharp blow, been dropped, or otherwise damaged in any way.** *Take it to an authorised service centre.*
- **Do not disassemble charger; take it to an authorised service centre when service or repair is required.** *Incorrect reassembly may result in a risk of electrical shock, electrocution or fire.*
- **In case of damaged power supply cord, the supply cord must be replaced immediately by the manufacturer, its service agent or similar qualified person to prevent any hazard.**
- **Disconnect the charger from the outlet before attempting any cleaning. This will reduce the risk of electric shock.** *Removing the battery pack will not reduce this risk.*
- **NEVER attempt to connect 2 chargers together.**
- **The charger is designed to operate on standard 230V household electrical power. Do not attempt to use it on any other voltage.** *This does not apply to the vehicular charger.*
- **Take care to ensure that the charger is standing in a steady, secure position.** *A falling battery or charger may present a risk of injury to yourself and/or others.*



- ***The location in which the charger is used should be clean and dry. Use of a charger in a dirty or wet area could result in risk of fire, electric shock, or electrocution.***

## SAVE THESE INSTRUCTIONS

### Package Contents

The package contains:

- 1 Battery charger
- 1 Instruction manual

**NOTE:** Battery packs, chargers and kitboxes are not included with N models.

- *Check for damage to the tool, parts or accessories which may have occurred during transport.*
- *Take the time to thoroughly read and understand this manual prior to operation.*

### Markings on Tool

The following pictograms are shown on the tool:



Read instruction manual before use.

### Date Code Position (Fig. A)

The date code **4**, which also includes the year of manufacture, is printed into the housing.

Example:

2021 XX XX

Year and Week of Manufacture

### Description (Fig. A)



**WARNING:** *Never modify the power tool or any part of it. Damage or personal injury could result.*

- 1 Battery
- 2 Battery release button
- 3 Charger

### Intended Use

The DCB1104 charger is designed for charging 18V DEWALT Li-Ion XR and XR FLEXVOLT battery packs: DCB181, DCB182, DCB183, DCB183B, DCB183G, DCB184, DCB184B, DCB184G, DCB185, DCB187, DCB189, DCB546, DCB547, DCB548, DCB549, DCBP034.

**DO NOT** use under wet conditions or in the presence of flammable liquids or gases. These battery chargers and battery packs are professional power tools.







## Charging a Battery

**NOTE:** To ensure maximum performance and life of lithium-ion battery packs, charge the battery pack fully before first use.

1. Plug the charger into an appropriate outlet before inserting battery pack.
2. Insert the battery pack **1** into the charger, making sure the battery pack is fully seated in the charger. The red (charging) light will blink repeatedly indicating that the charging process has started.
3. The Stage 1 Charging blink indicator represents the charge process that charges the majority of the battery's capacity. Stage 2 Charging blink indicator represents the remainder, or top off charge process, for the battery to reach full capacity.
4. The completion of charge for Stage 1 or Stage 2 will be indicated by the Stage's light remaining ON continuously. The battery pack is fully charged when both Stage 1 and Stage 2 charging lights remain ON continuously, and it may be removed and used at this time or left in the charger.

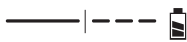
**NOTE:** To remove the battery pack, some chargers require the battery pack release button to be pressed.

### Indicators

	Stage 1 Charging	
	Stage 2 Charging	
	Fully Charged	
	Hot/Cold Pack Delay*	

\*The red light will continue to blink, but a yellow indicator light will be illuminated during this operation. Once the battery pack has reached an appropriate temperature, the yellow light will turn off and the charger will resume the charging procedure.

The compatible charger(s) will not charge a faulty battery pack. The charger will indicate faulty battery by refusing to light.

**NOTE:** This could also mean a problem with a charger.

If the charger indicates a problem, take the charger and battery pack to be tested at an authorised service centre.

## Hot/Cold Pack Delay

When the charger detects a battery pack that is too hot or too cold, it automatically starts a Hot/Cold Pack Delay, suspending charging until the battery pack has reached an appropriate temperature. The charger then automatically switches to the pack charging mode. This feature ensures maximum battery pack life.

A cold battery pack will charge at a slower rate than a warm battery pack.

## Electronic Protection System

XR Li-Ion tools are designed with an Electronic Protection System that will protect the battery pack against overloading, overheating or deep discharge.

The tool will automatically turn off if the Electronic Protection System engages. If this occurs, place the lithium-ion battery pack on the charger until it is fully charged.

## Wall Mounting

These chargers are designed to be wall mountable or to sit upright on a table or work surface. If wall mounting, locate the charger within reach of an electrical outlet, and away from a corner or other obstructions which may impede air flow. Use the back of the charger as a template for the location of the mounting screws on the wall. Mount the charger securely using drywall screws (purchased separately) at least 25.4 mm long with a screw head diameter of 7–9 mm, screwed into wood to an optimal depth leaving approximately 5.5 mm of the screw exposed. Align the slots on the back of the charger with the exposed screws and fully engage them in the slots.

## MAINTENANCE

Your power tool has been designed to operate over a long period of time with a minimum of maintenance. Continuous satisfactory operation depends upon proper tool care and regular cleaning.



**WARNING:** *To reduce the risk of serious personal injury, turn tool off and disconnect battery pack before making any adjustments or removing/installing attachments or accessories. An accidental start-up can cause injury.*

The charger and battery pack are not serviceable.



## Lubrication

Your power tool requires no additional lubrication.



## Cleaning



**WARNING:** Blow dirt and dust out of the main housing with dry air as often as dirt is seen collecting in and around the air vents. Wear approved eye protection and approved dust mask when performing this procedure.

## Charger Cleaning Instructions



**WARNING:** Dirt and grease may be removed from the exterior of the charger using a cloth or soft non-metallic brush. Do not use water or any cleaning solutions. Never let any liquid get inside the tool; never immerse any part of the tool into a liquid.

## Optional Accessories



**WARNING:** Since accessories, other than those offered by DEWALT, have not been tested with this product, use of such accessories with this tool could be hazardous. To reduce the risk of injury, only DEWALT recommended accessories should be used with this product.

Consult your dealer for further information on the appropriate accessories.

## Protecting the Environment



Separate collection. Products and batteries marked with this symbol must not be disposed of with normal household waste.

Products and batteries contain materials that can be recovered or recycled reducing the demand for raw materials. Please recycle electrical products and batteries according to local provisions. Further information is available at [www.2helpU.com](http://www.2helpU.com).

## Rechargeable Battery Pack

This long life battery pack must be recharged when it fails to produce sufficient power on jobs which were easily done before. At the end of its technical life, discard it with due care for our environment:

- Run the battery pack down completely, then remove it from the tool.
- Li-Ion cells are recyclable. Take them to your dealer or a local recycling station. The collected battery packs will be recycled or disposed of properly.

DEWALT, Richard-Klinger-Straße 11,  
65510, Idstein, Germany







<b>Belgique et Luxembourg België en Luxemburg</b>	DeWALT - Belgium BVBA Egide Walschaertsstraat 16 2800 Mechelen	Tel: NL 32 15 47 37 63 Tel: FR 32 15 47 37 64 Fax: 32 15 47 37 99	<a href="mailto:www.dewalt.be">www.dewalt.be</a> <a href="mailto:enduser.BE@sbdinc.com">enduser.BE@sbdinc.com</a>
<b>Danmark</b>	DeWALT (Stanley Black&Decker AS) Roskildevej 22 2620 Albertslund	Tel: 70 20 15 10 Fax: 70 22 49 10	<a href="mailto:www.dewalt.dk">www.dewalt.dk</a> <a href="mailto:kundeservice.dk@sbdinc.com">kundeservice.dk@sbdinc.com</a>
<b>Deutschland</b>	DeWALT Richard Klingner Str. 11 655 10 Idstein	Tel: 06126-21-0 Fax: 06126-21-2770	<a href="mailto:www.dewalt.de">www.dewalt.de</a> <a href="mailto:infodwge@sbdinc.com">infodwge@sbdinc.com</a>
<b>Ελλάς</b>	DeWALT (Ελλάς) Α.Ε. ΕΔΡΑ-ΓΡΑΦΕΙΑ : Στραβωνος 7 & Λ. Βουλιαγμένης, Γλυφάδα 166 74, Αθήνα SERVICE : Ημερος Τόπος 2 (Χάνι Αδάμ) – 193 00 Ασπρόπυργος	Τηλ: 00302108981616 Φαξ: 00302108983570	<a href="mailto:www.dewalt.gr">www.dewalt.gr</a> <a href="mailto:Greece.Service@sbdinc.com">Greece.Service@sbdinc.com</a>
<b>España</b>	DeWALT Ibérica, S.C.A. Parc de Negocios "Mas Blau" Edificio Muntadas, c/Bergadà, 1, Of. A6 08820 El Prat de Llobregat (Barcelona)	Tel: 934 797 400 Fax: 934 797 419	<a href="mailto:www.dewalt.es">www.dewalt.es</a> <a href="mailto:respuesta.postventa@sbdinc.com">respuesta.postventa@sbdinc.com</a>
<b>France</b>	DeWALT (Stanley Black & Decker France SAS) 62 Chemin de la Bruyère CS 60105, 69574 DARDILLY Cedex	Tel: 04 72 20 39 20 Fax: 04 72 20 39 00	<a href="mailto:www.dewalt.fr">www.dewalt.fr</a> <a href="mailto:scuff@sbdinc.com">scuff@sbdinc.com</a>
<b>Schweiz Suisse Svizzera</b>	DeWALT In der Luberzen 42 8902 Urdorf	Tel: 044 - 755 60 70 Fax: 044 - 730 70 67	<a href="mailto:www.dewalt.ch">www.dewalt.ch</a> <a href="mailto:service@rofoag.ch">service@rofoag.ch</a>
<b>Ireland</b>	DeWALT Building 4500, Kinsale Road Cork Airport Business Park Cork, Ireland	Tel: 00353-2781800 Fax: 01278 1811	<a href="mailto:www.dewalt.ie">www.dewalt.ie</a> <a href="mailto:Sales.ireland@sbdinc.com">Sales.ireland@sbdinc.com</a>
<b>Italia</b>	DeWALT via Energypark 6 20871 Vimercate (MB), IT	Tel: 800-014353 39 039-9590200 Fax: 39 039-9590311	<a href="mailto:www.dewalt.it">www.dewalt.it</a>
<b>Nederlands</b>	DeWALT Netherlands BVPostbus 83, 6120 AB BORN	Tel: 31 164 283 063 Fax: 31 164 283 200	<a href="mailto:www.dewalt.nl">www.dewalt.nl</a>
<b>Norge</b>	DeWALT Postboks 4613 0405 Oslo, Norge	Tel: 45 25 13 00 Fax: 45 25 08 00	<a href="mailto:www.dewalt.no">www.dewalt.no</a> <a href="mailto:kundeservice.no@sbdinc.com">kundeservice.no@sbdinc.com</a>
<b>Österreich</b>	DeWALT Werkzeug Vertriebsges m.b.H Oberlaaerstrasse 248, A-1230 Wien	Tel: 01 - 66116 - 0 Fax: 01 - 66116 - 614	<a href="mailto:www.dewalt.at">www.dewalt.at</a> <a href="mailto:service.austria@sbdinc.com">service.austria@sbdinc.com</a>
<b>Portugal</b>	DeWALT Ed. D Dinis, Quina da Fonte Rua dos Malhoes 2 2A 2º Esq. Oeiras e S. Juliao da Barra, paço de Arcos e Caxias 2770 071 Paço de Arcos	Tel: +351 214667500 Fax: +351214667580	<a href="mailto:www.dewalt.pt">www.dewalt.pt</a> <a href="mailto:resposta.posvenda@sbdinc.com">resposta.posvenda@sbdinc.com</a>
<b>Suomi</b>	DeWALT PL47 00521 Helsinki, Suomi	Puh: 010 400 4333 Faksi: 0800 411 340	<a href="mailto:www.dewalt.fi">www.dewalt.fi</a> <a href="mailto:asiakaspalvelu.fi@sbdinc.com">asiakaspalvelu.fi@sbdinc.com</a>
<b>Sverige</b>	DeWALT BOX 94 43122 Mölndal Sverige	Tel: 031 68 61 60 Fax: 031 68 60 08	<a href="mailto:www.dewalt.se">www.dewalt.se</a> <a href="mailto:kundservice.se@sbdinc.com">kundservice.se@sbdinc.com</a>
<b>Türkiye</b>	Sanayi ve Ticaret Bakanlığı tebliğince kullanımı ömrü 7 yıldır. Stanley Black & Decker Turkey Alet Üretim San. Tic. Ltd.Şti. AND Kozyatağı - İçerenköy Mah. Umur Sok. AND Ofis Sit. No: 10-12 / 82-83-84 Ataşehir/İstanbul, Türkiye	Tel: +90 216 665 2900 Faks: +90 216 665 2901	<a href="mailto:www.dewalt.com.tr">www.dewalt.com.tr</a> <a href="mailto:support@dewalt.com.tr">support@dewalt.com.tr</a>
<b>United Kingdom</b>	DeWALT, 270 Bath Road, Slough, Berks SL1 4DX	Tel: 01753-567055 Fax: 01753-572112	<a href="mailto:www.dewalt.co.uk">www.dewalt.co.uk</a> <a href="mailto:emeaservice@sbdinc.com">emeaservice@sbdinc.com</a>
<b>Australia</b>	DeWALT 810 Whitehorse Road Box Hill VIC 3128 Australia	Tel: Aust 1800 338 002 Tel: NZ 0800 339 258	<a href="mailto:www.dewalt.com.au">www.dewalt.com.au</a> <a href="mailto:www.dewalt.co.nz">www.dewalt.co.nz</a>
<b>Middle East Africa</b>	DeWALT P.O. Box - 17164, Jebel Ali Free Zone (South), Dubai, UAE	Tel: 971 4 812 7400 Fax: 971 4 2822765	<a href="mailto:www.dewalt.ae">www.dewalt.ae</a> <a href="mailto:support@dewalt.ae">support@dewalt.ae</a>