

Questions? See us in the World Wide Web at www.dewalt.com

INSTRUCTIVO DE OPERACIÓN, CENTROS DE SERVICIO Y PÓLIZA DE GARANTÍA. ADVERTENCIA: LEASE ESTE INSTRUCTIVO ANTES DE USAR EL PRODUCTO.

INSTRUCTION MANUAL
GUIDE D'UTILISATION
MANUAL DE INSTRUCCIONES

DEWALT®

DW378, DW378G, DW378GT
7-1/4" (184 mm) Framing Saw
Scie circulaire pour la charpente de 184 mm (7 1/4 po)
Siera alternataiva de 184 mm (7-1/4")

DeWALT Industrial Tool Co., 701 East Joppa Road, Baltimore, MD 21286 (JUL04-CD-1)
Form No. 626678-00 DW378, DW378G, DW378GT Copyright © 1998, 2002, 2004 DeWALT
The following are trademarks for one or more DeWALT power tools: the yellow and black color scheme; the "D" shaped air intake grill; the array of pyramids on the handgrip; the kit box configuration; and the array of lozenge-shaped humps on the surface of the tool.

IF YOU HAVE ANY QUESTIONS OR COMMENTS ABOUT THIS OR ANY DeWALT TOOL, CALL US TOLL FREE AT: 1-800-4-DEWALT (1-800-433-9258)

General Safety Instructions

⚠ WARNING! Read and understand all instructions. Failure to follow all instructions listed below, may result in electric shock, fire and/or serious personal injury.

SAVE THESE INSTRUCTIONS

WORK AREA

- Keep your work area clean and well lit. Cluttered benches and dark areas invite accidents.
- Do not operate power tools in explosive atmospheres, such as in the presence of flammable liquids, gases, or dust. Power tools create sparks which may ignite the dust or fumes.
- Keep bystanders, children, and visitors away while operating a power tool. Distractions can cause you to lose control.

ELECTRICAL SAFETY

- Grounded tools must be plugged into an outlet properly installed and grounded in accordance with all codes and ordinances. Never remove the grounding prong or modify the plug in any way. Do not use any adaptor plugs. Check with a qualified electrician if you are in doubt as to whether the outlet is properly grounded. If the tools should electrically malfunction or break down, grounding provides a low resistance path to carry electricity away from the user. Applicable only to Class I (grounded) tools. The DW378G and DW378GT are grounded tools.
- Double insulated tools are equipped with a polarized plug (one blade is wider than the other.) This plug will fit in a polarized outlet only one way. If the plug does not fit fully in the outlet, reverse the plug. If it still does not fit, contact a qualified electrician to install a polarized outlet. Do not change the plug in any way. Double insulation  eliminates the need for the three wire grounded power cord and grounded power supply system. Applicable only to Class II (double insulated) tools. The DW378 is a double insulated tool.
- Avoid body contact with grounded surfaces such as pipes, radiators, ranges and refrigerators. There is an increased risk of electric shock if your body is grounded.
- Don't expose power tools to rain or wet conditions. Water entering a power tool will increase the risk of electric shock.
- Do not abuse the cord. Never use the cord to carry the tools or pull the plug from an outlet. Keep cord away from heat, oil, sharp edges or moving parts. Replace damaged cords immediately. Damaged cords increase the risk of electric shock.
- When operating a power tool outside, use an outdoor extension cord marked "W-A" or "W." These cords are rated for outdoor use and reduce the risk of electric shock. When using an extension cord, be sure to use one heavy enough to carry the current your product will draw. An undersized cord will cause a drop in line voltage resulting in loss of power and overheating. The following table shows the correct size to use depending on cord length and nameplate ampere rating. If in doubt, use the next heavier gage. The smaller the gage number, the heavier the cord.

Volts	Minimum Gage for Cord Sets			
	Total Length of Cord in Feet			
120V	0-25	26-50	51-100	101-150
240V	0-50	51-100	101-200	201-300
Ampere Rating				
More Than		Not more Than		
10-	12	16	16	14
12-	16	14	12	Not Recommended

PERSONAL SAFETY

- Stay alert, watch what you are doing and use common sense when operating a power tool. Do not use tool while tired or under the influence of drugs, alcohol, or medication. A moment of inattention while operating power tools may result in serious personal injury.
- Dress properly. Do not wear loose clothing or jewelry. Contain long hair. Keep your hair, clothing, and gloves away from moving parts. Loose clothing, jewelry, or long hair can be caught in moving parts. Air vents often cover moving parts and should also be avoided.
- Avoid accidental starting. Be sure switch is off before plugging in. Carrying tools with your finger on the switch or plugging in tools that have the switch on invites accidents.
- Remove adjusting keys or wrenches before turning the tool on. A wrench or a key that is left attached to a rotating part of the tool may result in personal injury.
- Do not overreach. Keep proper footing and balance at all times. Proper footing and balance enables better control of the tool in unexpected situations.
- Use safety equipment. Always wear eye protection. Dust mask, non-skid safety shoes, hard hat, or hearing protection must be used for appropriate conditions.

TOOL USE AND CARE

- Use clamps or other practical way to secure and support the workpiece to a stable platform. Holding the work by hand or against your body is unstable and may lead to loss of control.
- Do not force tool. Use the correct tool for your application. The correct tool will do the job better and safer at the rate for which it is designed.
- Do not use tool if switch does not turn it on or off. Any tool that cannot be controlled with the switch is dangerous and must be repaired.

- Disconnect the plug from the power source before making any adjustments, changing accessories, or storing the tool. Such preventative safety measures reduce the risk of starting the tool accidentally.
- Store idle tools out of reach of children and other untrained persons. Tools are dangerous in the hands of untrained users.
- Maintain tools with care. Keep cutting tools sharp and clean. Properly maintained tools, with sharp cutting edges are less likely to bind and are easier to control.
- Check for misalignment or binding of moving parts, breakage of parts, and any other condition that may affect the tools operation. If damaged, have the tool serviced before using. Many accidents are caused by poorly maintained tools.
- Use only accessories that are recommended by the manufacturer for your model. Accessories that may be suitable for one tool, may become hazardous when used on another tool.

SERVICE

- Tool service must be performed only by qualified repair personnel. Service or maintenance performed by unqualified personnel could result in a risk of injury.
- When servicing a tool, use only identical replacement parts. Follow instructions in the Maintenance section of this manual. Use of unauthorized parts or failure to follow Maintenance Instructions may create a risk of electric shock or injury.

Additional Safety Instructions for Circular Saws

⚠ DANGER! Keep hands away from cutting area and blade. Keep your second hand on auxiliary handle, or motor housing. If both hands are holding the saw, they cannot be cut by the blade.

⚠ CAUTION: Blades coast after turn off.

- Keep your body positioned to either side of the blade, but not in line with the saw blade. KICKBACK could cause the saw to jump backwards (see Causes and Operator Prevention of Kickback and KICKBACK).
- Do not reach underneath the work. The guard can not protect you from the blade below the work.
- Check lower guard for proper closing before each use. Do not operate saw if lower guard does not move freely and close instantly. Never clamp or tie the lower guard into the open position. If saw is accidentally dropped, the lower guard may be bent. Raise the lower guard with the retracting handle and make sure it moves freely and does not touch the blade or any other part, at all angles and depth of cut.
- Check the operation and condition of the lower guard spring. If the guard and the spring are not operating properly, they must be serviced before use. Lower guard may operate sluggishly due to damaged parts, gummy deposits, or a buildup of debris.
- Lower guard should be retracted manually only for special cuts such as "pocket cuts" and "compound cuts." Raise lower guard by retracting handle. As soon as blade enters the material, lower guard must be released. For all other sawing, the lower guard should be allowed to operate automatically.
- Always observe that the lower guard is covering the blade before placing saw down on bench or floor. An unprotected, coasting blade will cause the saw to walk backwards, cutting whatever is in its path. Be aware of the time it takes for the blade to stop after switch is released.
- NEVER hold piece being cut in your hands or across your leg. It is important to support the work properly to minimize body exposure, blade binding, or loss of control.
- Hold tool by insulated gripping surfaces when performing an operation where the cutting tool may contact hidden wiring or its own cord. Contact with a "live" wire will also make exposed metal parts of the tool "live" and shock the operator.
- When ripping, always use a rip fence or straight edge guide. This improves the accuracy of cut and reduces the chance for blade binding.
- Always use blades with correct size and shape (diamond vs. round) arbor holes. Blades that do not match the mounting hardware of the saw will run eccentrically, causing loss of control.
- Never use damaged or incorrect blade washers or bolts. The blade washers and bolt were specially designed for your saw, for optimum performance and safety of operation.
- Avoid cutting nails. Inspect for and remove all nails from lumber before cutting.

CAUSES AND OPERATOR PREVENTION OF KICKBACK

- Kickback is a sudden reaction to a pinched, bound or misaligned saw blade, causing an uncontrolled saw to lift up and out of the workpiece toward the operator.
- When the blade is pinched or bound tightly by the kerf closing down, the blade stalls and the motor reaction drives the unit rapidly back toward the operator.
- If the blade becomes twisted or misaligned in the cut, the teeth at the back edge of the blade can dig into the top surface of the wood causing the blade to climb out of the kerf and jump back toward operator.
- Kickback is the result of tool misuse and/or incorrect operating procedures or conditions and can be avoided by taking proper precautions as given below:
- Maintain a firm grip with both hands on the saw and position your body and arm to allow you to resist kickback forces. Kickback forces can be controlled by the operator, if proper precautions are taken.
- When blade is binding, or when interrupting a cut for any reason, release the trigger and hold the saw motionless in the material until the blade comes to a complete stop. Never attempt to remove the saw from the work or pull the saw backward while the blade is in motion or kickback may occur. Investigate and take corrective actions to eliminate the cause of blade binding.
- When restarting a saw in the workpiece, center the saw blade in the kerf and check that the saw teeth are not engaged into the material. If saw blade is binding, it may walk up or kickback from the workpiece as the saw is restarted.
- Support large panels to minimize the risk of blade pinching and kickback. Large panels tend to sag under their own weight. Support must be placed under the panel on both sides, near the line of cut and near the edge of the panel.
- Do not use dull or damaged blade. Unsharpened or improperly set blades produce narrow kerf causing excessive friction, blade binding, and kickback.
- Blade depth and bevel adjusting locking levers must be tight and secure before making cut. If blade adjustment shifts while cutting, it may cause binding and kickback.
- Use extra caution when making a "Pocket Cut" into existing walls or other blind areas. The protruding blade may cut objects that can cause kickback.

⚠ WARNING: Some dust created by power sanding, sawing, grinding, drilling, and other construction activities contains chemicals known to cause cancer, birth defects or other reproductive harm. Some examples of these chemicals are:

- lead from lead-based paints,
- crystalline silica from bricks and cement and other masonry products, and
- arsenic and chromium from chemically-treated lumber (CCA).

Your risk from these exposures varies, depending on how often you do this type of work. To reduce your exposure to these chemicals: work in a well ventilated area, and work with approved safety equipment, such as those dust masks that are specially designed to filter out microscopic particles.

- Avoid prolonged contact with dust from power sanding, sawing, grinding, drilling, and other construction activities. Wear protective clothing and wash exposed areas with soap and water. Allowing dust to get into your mouth, eyes, or lay on the skin may promote absorption of harmful chemicals.



⚠ WARNING: Use of this tool can generate and/or disburse dust, which may cause serious and permanent respiratory or other injury. Always use NIOSH/OSHA approved respiratory protection appropriate for the dust exposure. Direct particles away from face and body.

⚠ WARNING: Always use eye protection. All users and bystanders must wear eye protection that conforms to ANSI Z87.1.

⚠ CAUTION: Wear appropriate personal hearing protection during use. Under some conditions and duration of use, noise from this product may contribute to hearing loss.

⚠ CAUTION: When cutting into walls, floors or wherever live electrical wires may be encountered, DO NOT TOUCH ANY METAL PARTS OF THE TOOL! Hold the tool only by insulated grasping surfaces to prevent electric shock if you cut into a live wire.

The label on your tool may include the following symbols. The symbols and their definitions are as follows:

V.....volts	A.....amperes
Hz.....hertz	W.....watts
min.....minutes	~.....alternating current
==== direct current	no.....no load speed
Class II Construction	earthing terminal
safety alert symbol	.../min.....revolutions per minute

FEATURES

- A. Brush inspection cover
- B. Trigger switch
- C. Cutting depth adjustment
- D. Bevel angle adjustment
- E. Shoe
- F. Blade clamping screw

Motor

Your DeWALT tool is powered by a DeWALT motor. Be sure your power supply agrees with nameplate marking. 120 Volts AC/DC means your saw will operate on alternating or direct current. As little as 10% lower voltage can cause loss of power and can result in overheating. All DeWALT tools are factory-tested; if this tool does not operate, check the power supply.

Changing Blades

⚠CAUTION: Turn off and unplug the tool before making any adjustments or removing/installing attachments or accessories.

TO INSTALL THE BLADE

- Place inner clamp washer (G) on saw spindle with the large flat surface facing out toward the blade (Fig. 1).
- Retract the lower blade guard (H) and place blade on saw spindle against the inner clamp washer, making sure that the blade will rotate in the proper direction (the direction of the rotation arrow on the saw blade and the teeth must point in the same direction as the direction of rotation arrow on the saw). Do not assume that the printing on the blade will always be facing you when properly installed. When retracting the lower blade guard to install the blade, check the condition and operation of the lower blade guard to assure that it is working properly. Make sure it moves freely and does not touch the blade or any other part, in all angles and depths of cut.
- Place outer clamp washer (I) on saw spindle with the large flat surface against the blade and the wording on the outer clamp washer facing you.
- Thread blade clamping screw (F) into saw spindle by hand (screw has left-hand threads and must be turned counterclockwise to tighten).
- Depress the blade lock (J) while turning the saw spindle with the blade wrench until the blade lock engages and the blade stops rotating (Fig. 3).
- Tighten the blade clamping screw firmly with the blade wrench.

NOTE: Never engage the blade lock while saw is running, or engage in an effort to stop the tool. Never turn the saw on while the blade lock is engaged. Serious damage to your saw will result.

TO REPLACE THE BLADE

- To loosen the blade clamping screw (F), depress the blade lock (J) and turn the saw spindle with the blade wrench until the blade lock engages and the blade stops rotating. With the blade lock engaged, turn the blade clamping screw clockwise with the blade wrench (screw has left-hand threads and must be turned clockwise to loosen).
- Remove the blade clamping screw (F) and outer clamp washer (I) only. Remove old blade.
- Clean any sawdust that may have accumulated in the guard or clamp washer area and check the condition and operation of the lower blade guard as previously outlined. Do not lubricate this area.
- Select the proper blade for the application (see Blades). Always use blades that are the correct size (diameter) with the proper size and shape center hole for mounting on the saw spindle. Always assure that the maximum recommended speed (rpm) on the saw blade meets or exceeds the speed (rpm) of the saw.
- Follow steps 2 through 6 under To Install the Blade, making sure that the blade will rotate in the proper direction.

LOWER BLADE GUARD

⚠WARNING: The lower blade guard is a safety feature which reduces the risk of serious personal injury. Never use the saw if the lower guard is missing, damaged, misassembled or not working properly. Do not rely on the lower blade guard to protect you under all circumstances. Your safety depends on following all warnings and precautions as well as proper operation of the saw. Check lower guard for proper closing before each use as outlined in Additional Safety Rules for Circular Saws. If the lower blade guard is missing or not working properly, have the saw serviced before using. To assure product safety and reliability, repair, maintenance and adjustment should be performed by an authorized service center or other qualified service organization, always using identical replacement parts.

Cutting Depth Adjustment

⚠CAUTION: Turn off and unplug the tool before making any adjustments or removing/installing attachments or accessories.

Hold the saw firmly. Raise the depth adjustment lever (C) to loosen and move shoe to obtain the desired depth of cut, as shown. Make sure the depth adjustment lever has been retightened (lowered) before operating saw (Fig. 4).

Your saw is equipped with a carbide tipped saw blade for long life and efficient cutting.

Setting the saw at the proper cutting depth keeps blade friction to a minimum, removes sawdust from between the blade teeth, results in cooler, faster sawing and reduces the chance of kickback. Align the appropriate mark on the depth adjustment strap with triangle on the upper blade guard. Your depth is set.

For the most efficient cutting action using a carbide tipped saw blade, set the Depth Adjustment so that about one half of a tooth projects below the surface of the wood to be cut (Figure 5). A method of checking for the correct cutting depth is shown in Figure 6. Lay a piece of the material you plan to cut along the side of the blade, as shown in the figure, and observe how much tooth projects beyond the material.

Bevel Angle Adjustment

⚠CAUTION: Turn off and unplug the tool before making any adjustments or removing/installing attachments or accessories.

The full range of the bevel adjustment is from **0 TO 50 DEGREES**. The quadrant is graduated in increments of 5 degrees.

On the front of the saw is a bevel angle adjustment mechanism (Fig. 8) consisting of a calibrated quadrant (L) and a lever (M). To set the saw for a bevel cut, raise to loosen the Bevel Adjustment lever and tilt shoe to the desired angle by aligning the pointer (N) with the desired angle mark. Retighten lever firmly by lowering it.

KERF INDICATOR

The front of the saw shoe has a kerf indicator (Figure 10) for vertical and bevel cutting. This indicator enables you to guide the saw along cutting lines penciled on the material being cut. The indicator lines up with the left (outer) side of the saw blade, which makes the slot or "kerf" cut by the moving blade fall to the right of the indicator. The ribs on the front of the shoe are at 1/2" (13mm) spacing.

OPERATION

Switch (Fig. 1)

Pull the trigger switch (B) to turn the motor ON. Releasing the trigger turns the motor OFF. This tool has no provision to lock the switch in the ON position, and should never be locked ON in any way.

Workpiece Support

Figure 11 and 13 show proper sawing position. Figure 12 and 14 show an unsafe condition. Hands should be kept away from cutting area, and power cord is positioned clear of the cutting area so that it will not get caught or hung up on the work.

To avoid kickback, DO support board or panel NEAR the cut, (Fig. 11, 13). DON'T support board or panel away from the cut (Fig. 12, 14). When operating the saw, keep the cord away from the cutting area and prevent it from becoming hung up on the work piece.

⚠WARNING: It is important to support the work properly and to hold the saw firmly to prevent loss of control which could cause personal injury; Figure 14 illustrates typical hand support of the saw.

ALWAYS DISCONNECT SAW BEFORE MAKING ANY ADJUSTMENTS! Place the work with its "good" side - the one on which appearance is most important - down. The saw cuts upward, so any splintering will be on the work face that is up when you saw it.

Cutting

Support the work so that the waste will be on your left. Place the wider portion of the saw shoe on that part of the work piece which is solidly supported, not on the section that will fall off when the cut is made. As examples, Figure 13 illustrates the RIGHT way to cut off the end of a board, and Figure 14 the WRONG way. Always clamp work. Don't try to hold short pieces by hand! Remember to support cantilevered and overhanging material. Use caution when sawing material from below.

Be sure saw is up to full speed before blade contacts material to be cut. Starting saw with blade against material to be cut or pushed forward into kerf can result in kickback.

Push the saw forward at a speed which allows the blade to cut without laboring. Hardness and toughness can vary even in the same piece of material, and knotty or damp sections can put a heavy load on the saw. When this happens, push the saw more slowly, but hard enough to keep it working without much decrease in speed.

Sawhook

Your saw has a convenient saw hook to allow you to hang the saw on a joist or rafter. The sawhook folds flat against the tool handle when not in use.

To use the sawhook, push down on the hook and rotate it outwards from the handle. It will latch into position. (Fig. 15)

To return the sawhook to its stored position, push down on the hook and rotate it back towards the handle. It will latch into position.

Kickback

When the saw blade becomes pinched or twisted in the cut, kickback can occur. The saw is thrust rapidly back toward the operator. When the blade is pinched or bound tightly by the kerf closing down, the blade stalls and the motor reaction drives the unit backward. When the blade becomes twisted or misaligned in the cut, the teeth at the back edge of the blade can dig into the top surface of the wood causing the blade to climb out of the kerf and jump back toward the operator.

Kickback is more likely to occur when any of the following conditions exist.

1. IMPROPER WORKPIECE SUPPORT

- Sagging or improper lifting of the cut off piece causing pinching of the blade. (Figure 12)
- Cutting through material supported at the outer ends only (see Figure 12). As the material weakens it sags, closing down the kerf and pinching the blade.
- Cutting off a cantilevered or overhanging piece of material from the bottom up in a vertical direction. The falling cut off piece can pinch the blade. (Figure 14)
- Cutting off long narrow strips (as in ripping). The cut off strip can sag or twist closing the kerf and pinching the blade.

FIG. 1

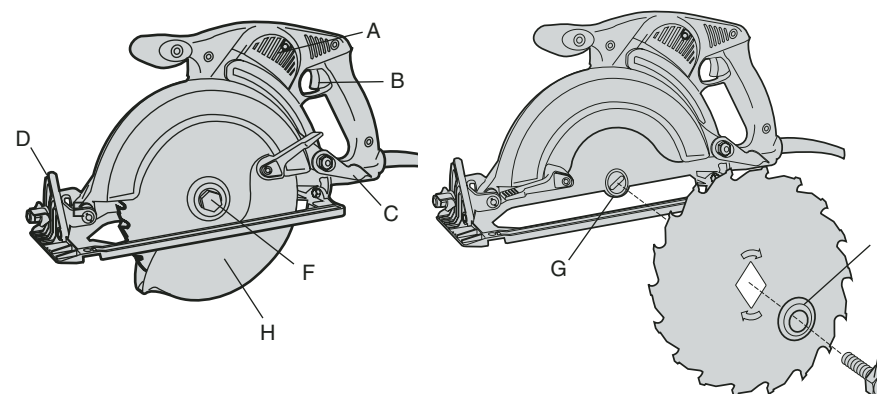

FIG. 2

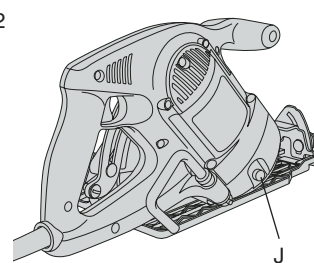
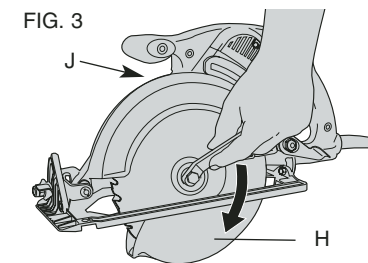

FIG. 3



LOOSEN (clockwise)
DESSERRER (vers la droite)
AFLOJAR (dirección de las manillas del reloj)

TIGHTEN (counterclockwise)
SERRER (vers la gauche)
AJUSTAR (dirección contraria a las manillas del reloj)

FIG. 4

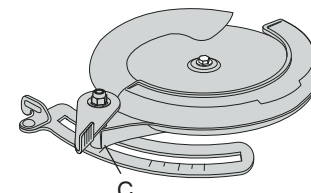

FIG. 5

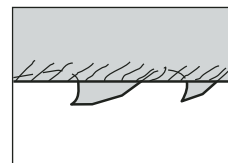

FIG. 6

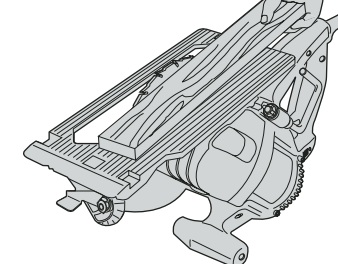

FIG. 7

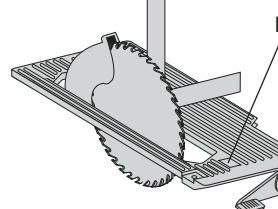

FIG. 8

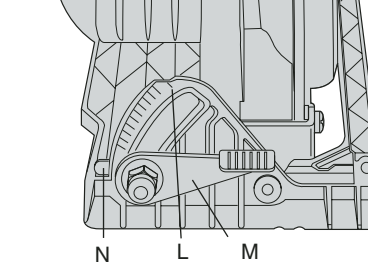

FIG. 9

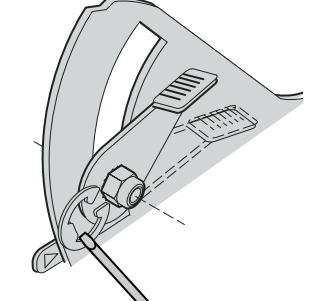

FIG. 10

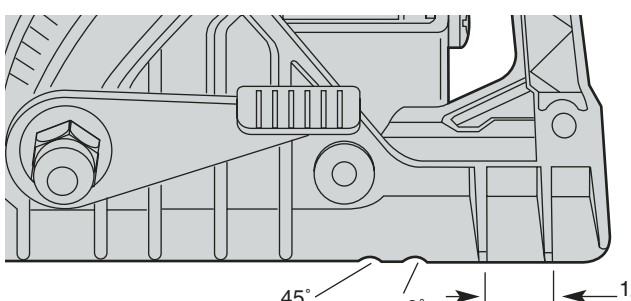

FIG. 11

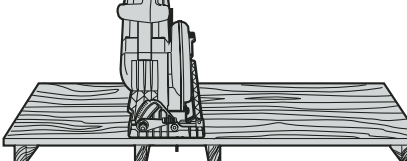

FIG. 12

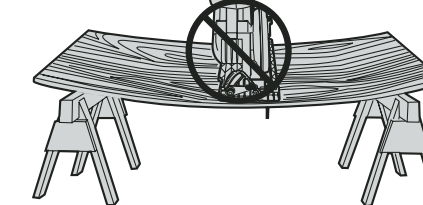

FIG. 13

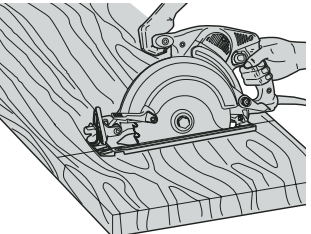

FIG. 14

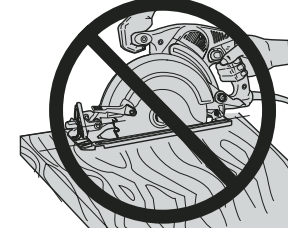
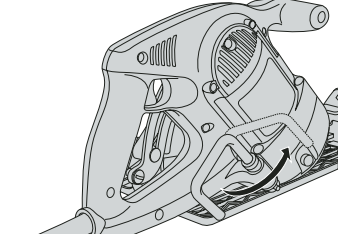

FIG. 15



E. Snagging the lower guard on a surface below the material being cut momentarily reducing operator control. The saw can lift partially out of the cut increasing the chance of blade twist.

2. IMPROPER DEPTH OF CUT SETTING ON SAW

Using the saw with an excessive depth of cut setting increases loading on the unit and susceptibility to twisting of the blade in the kerf. It also increases the surface area of the blade available for pinching under conditions of kerf close down. See CUTTING DEPTH ADJUSTMENT.

3. BLADE TWISTING (MISALIGNMENT IN CUT)

- Pushing harder to cut through a knot, a nail, or a hard grain area can cause the blade to twist.
- Trying to turn the saw in the cut (trying to get back on the marked line) can cause blade twist.
- Extended reach or operating saw with poor body control (out of balance), can result in twisting the blade.
- Changing hand grip or body position while cutting can result in blade twist.
- Backing unit up to clear blade can lead to twist if not done carefully.

4. MATERIALS THAT REQUIRE EXTRA ATTENTION

- Wet lumber
- Green lumber (material freshly cut or not kiln dried)
- Pressure treated lumber (material treated with preservatives or anti-rot chemicals)

5. USE OF DULL OR DIRTY BLADES

Dull blades cause increased loading of the saw. To compensate, an operator will usually push harder which further loads the unit and promotes twisting of the blade in the kerf. Worn blades may also have insufficient body clearance which increases the chance of binding and increased loading.

6. LIFTING THE SAW WHEN MAKING BEVEL CUTS

Bevel cuts require special operator attention to proper cutting techniques - especially guidance of the saw. Both blade angle to the shoe and greater blade surface in the material increase the chance for binding and misalignment (twist) to occur.

7. RESTARTING A CUT WITH THE BLADE TEETH JAMMED AGAINST THE MATERIAL

The saw should be brought up to full operating speed before starting a cut or restarting a cut after the unit has been stopped with the blade in the kerf. Failure to do so can cause stalling and kickback.

Any other conditions which could result in pinching, binding, twisting, or misalignment of the blade could cause kickback. Refer to the sections on "Adjustments And Set-Up" and "Operation" for procedures and techniques that will minimize the occurrence of kickback.

MAINTENANCE

Lubrication

Your saw has a sealed gear housing filled to the proper level with a high-performance gear lubricant. Adding excessive amounts of lubricant, or adding improper lubricant can cause leakage or premature gear failure.

Inspect your saw periodically for leakage. If you notice any leaks promptly return your saw to a service center for inspection and relubrication.

Brushes

CAUTION: Turn off and unplug the tool before making any adjustments or removing/installing attachments or accessories.

Inspect carbon brushes regularly by unplugging tool, removing the Brush Inspection Cover and withdrawing the brush assembly. Keep brushes clean and sliding freely in their guides. Always replace a used brush in the same orientation in the holder as it was prior to removal. Carbon brushes have varying symbols stamped into their sides, and if either brush is worn down to the line closest to the spring, they must be replaced. Use only identical DEWALT brushes. New brush assemblies are available at your local service center. The tool should be allowed to "run in" (run at no load without a blade) for 10 minutes before use to seat new brushes.

While "running in" DO NOT TIE, TAPE, OR OTHERWISE LOCK THE TRIGGER SWITCH ON. HOLD BY HAND ONLY.

SHOE ADJUSTMENT

CAUTION: Turn off and unplug the tool before making any adjustments or removing/installing attachments or accessories.

Your shoe has been factory set to assure that the blade is perpendicular to the shoe. If after extended use, you need to re-align the blade as follows:

ADJUSTING FOR 90 DEGREE CUTS (FIG. 7, 8)

1. Return the saw to 0 degrees bevel.
2. Place the saw on its side, and retract the lower guard.
3. Loosen the Bevel Adjustment Lever (M). Place a square against the blade and the shoe.
4. Using an Allen wrench, turn the set screw on the underside of the shoe (K) until the blade and the shoe are both in flush contact with the square. Retighten the Bevel Adjust Lever.

ADJUSTING DEPTH ADJUSTMENT AND BEVEL ADJUSTMENT LEVERS.

It may be desirable to adjust the the depth adjustment lever or the bevel adjustment lever. (They may loosen in time and hit the shoe before tightening). To tighten either, follow the steps below.

CAUTION: Turn off and unplug the tool before making any adjustments or removing/installing attachments or accessories.

1. Using a small screwdriver, pry the lock ring off, see Figure 9.
2. Remove the lever and rotate it in the desired direction about 1/8 of a revolution.
3. Reinstall the lock ring with the concave side against the lever to hold it in place.

Blades

A dull blade will cause slow, inefficient cutting, overload on the saw motor, excessive splintering and increase the possibility of kickback. Change blades when it is no longer easy to push the saw through the cut, when the motor is straining, or when excessive heat is built up in the blade. It is a good practice to keep extra blades on hand so that sharp blades are available for immediate use. Dull blades can be sharpened in most areas; see SAWS-SHARPENING in the yellow pages.

Hardened gum on the blade can be removed with trichlorethylene (nail polish remover), kerosene, turpentine, or oven cleaner. Anti-stick coated blades can be used in applications where excessive build-up is encountered, such as pressure treated and green lumber.

VISUALLY EXAMINE CARBIDE BLADES BEFORE USE. REPLACE IF DAMAGED.

COMBINATION FRAMING- All purpose fast rip and cross cuts.

PRESSURE TREATED/WET LUMBER- Coated - Resistant to build-up

EXTREME DURABILITY - Maximum impact resistance for longer life.

FINISHING - More teeth for finer finish cuts.

FAST CUT FRAMING - Fastest blade for rips and cross cuts

DEWALT also offers a full line of steel blades for specialty jobs such as plywood, non-ferrous metal, planing, and iron/steel.

NOTE: All DEWALT blades offer a diamond knockout for use on this saw.

Accessories

WATER FEED ATTACHMENTS ARE NOT RECOMMENDED FOR THIS SAW.

Recommended accessories for use with your tool are available at extra cost from your local service center.

CAUTION: The use of any non-recommended accessory may be hazardous.

If you need any assistance in locating any accessory, please contact DEWALT Industrial Tool Co., 701 East Joppa Road, Baltimore, MD 21286 or call 1-800-732-4441.

Repairs

To assure product safety and reliability, repairs, maintenance and adjustment should be performed by DEWALT Inc. Industrial Service Centers or other qualified service organizations, These service organizations service DEWALT tools always using DEWALT replacement parts.