

---

# **DEWALT**

---

## ***XR LI-ION***

**[www.DEWALT.com](http://www.DEWALT.com)**

**DCD734**

**DCD771**

**DCD776**

---

<b>English (<i>original instructions</i>)</b>	<b>3</b>
<b>中文 (简体)</b>	<b>14</b>
<b>中文 (繁體)</b>	<b>25</b>
<b>한국어</b>	<b>36</b>
<b>BAHASA INDONESIA</b>	<b>47</b>
<b>ภาษาไทย</b>	<b>58</b>
<b>TIẾNG VIỆT</b>	<b>69</b>

---

Figure 1

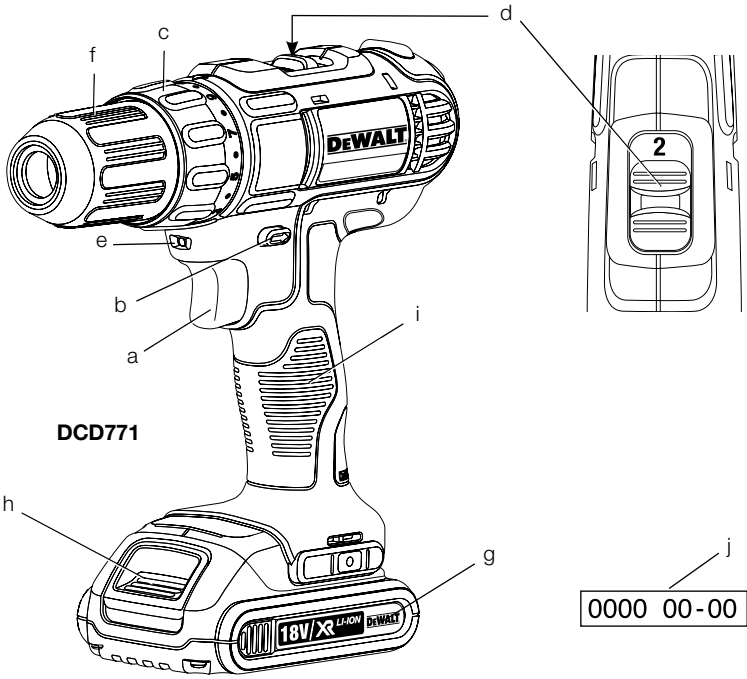

Figure 2

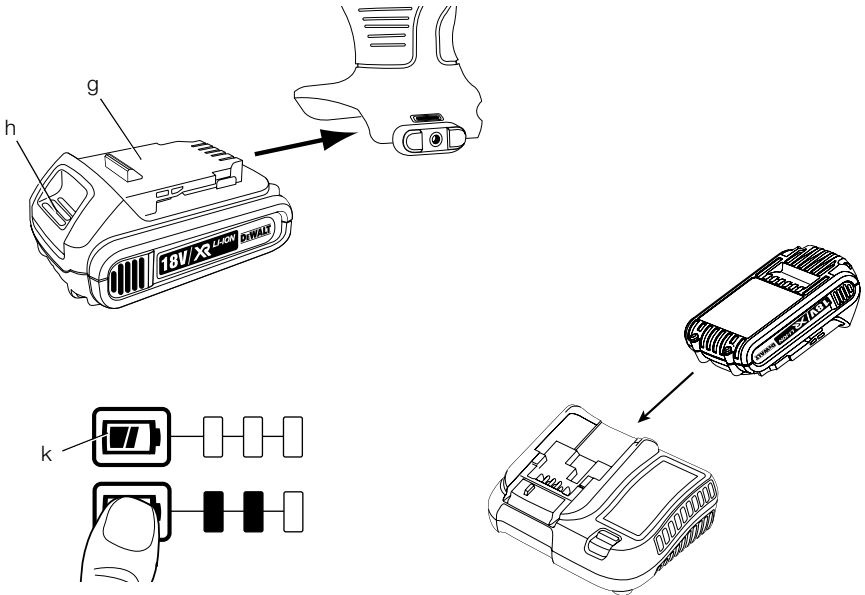

Figure 3

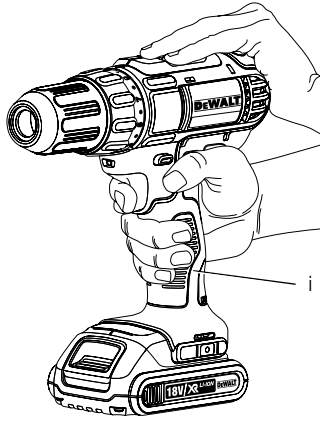

Figure 4

Figure 5

Figure 6

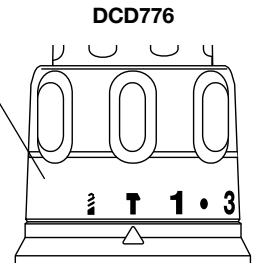
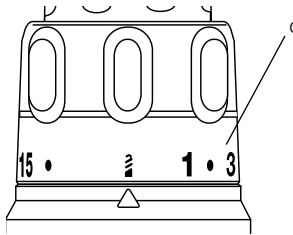
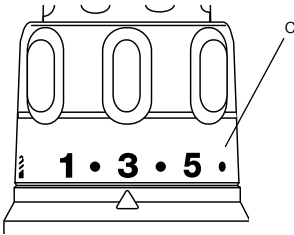
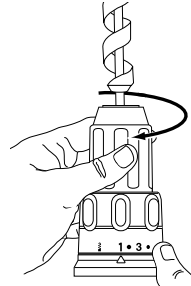
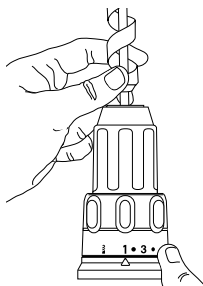
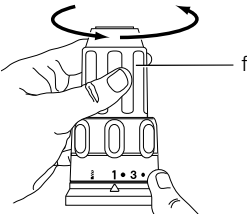

Figure 7

Figure 8

Figure 9



# CORDLESS COMPACT 13 mm (1/2") DRILL/DRIVER/ HAMMERDRILL

## DCD734, DCD771, DCD776

### Congratulations!

You have chosen a DEWALT tool. Years of experience, thorough product development and innovation make DEWALT one of the most reliable partners for professional power tool users.

### Technical Data

		DCD734	DCD771	DCD776
Voltage	$V_{DC}$	14.4	18	18
Type		1	1	1
Battery Type		Li-ION	Li-ION	Li-ION
Power output	W	250	300	300
No-load speed				
1st gear	$\text{min}^{-1}$	0–400	0–450	0–450
2nd gear	$\text{min}^{-1}$	0–1300	0–1500	0–1500
Impact rate				
1st gear	$\text{min}^{-1}$	–	–	0–7650
2nd gear	$\text{min}^{-1}$	–	–	0–25 500
Max. torque (hard/soft)	Nm	38/22	42/24	42/24
Chuck capacity	mm	13	13	13
Maximum drilling capacity				
Wood	mm	30	30	30
Metal	mm	10	13	13
Masonry	mm	–	–	13
Weight (without battery pack)	kg	1.2	1.3	1.34

Battery pack		DCB140	DCB141	DCB142	DCB143	DCB145
Battery type		Li-ION	Li-ION	Li-ION	Li-ION	Li-ION
Voltage	$V_{DC}$	14.4	14.4	14.4	14.4	14.4
Capacity	$A_h$	3.0	1.5	4.0	2.0	1.3
Weight	kg	0.53	0.30	0.54	0.30	0.30

Battery pack		DCB185	DCB181	DCB183	DCB180	DCB182
Battery type		Li-ION	Li-ION	Li-ION	Li-ION	Li-ION
Voltage	$V_{DC}$	18	18	18	18	18
Capacity	$A_h$	1.3	1.5	2.0	3.0	4.0
Weight	kg	0.35	0.35	0.40	0.64	0.61

Chargers		DCB107				
Mains voltage	$V_{AC}$	230 V				
Battery type		Li-ION				
Approx. charging time	min	60	70	90	140	185
		(1.3 Ah battery packs)	(1.5 Ah battery packs)	(2.0 Ah battery packs)	(3.0 Ah battery packs)	(4.0 Ah battery packs)
Weight	kg	0.49				

## Definitions: Safety Guidelines

The definitions below describe the level of severity for each signal word. Please read the manual and pay attention to these symbols.



**DANGER:** Indicates an imminently hazardous situation which, if not avoided, will result in **death or serious injury**.



**WARNING:** Indicates a potentially hazardous situation which, if not avoided, **could** result in **death or serious injury**.



**CAUTION:** Indicates a potentially hazardous situation which, if not avoided, **may** result in **minor or moderate injury**.

**NOTICE:** Indicates a practice **not related to personal injury** which, if not avoided, **may** result in **property damage**.



Denotes risk of electric shock.



Denotes risk of fire.



**WARNING:** To reduce the risk of injury, read the instruction manual.

## General Power Tool Safety Warnings



**WARNING!** Read all safety warnings and all instructions. Failure to follow the warnings and instructions may result in electric shock, fire and/or serious injury.

### SAVE ALL WARNINGS AND INSTRUCTIONS FOR FUTURE REFERENCE

The term "power tool" in the warnings refers to your mains-operated (corded) power tool or battery-operated (cordless) power tool.

#### 1) WORK AREA SAFETY

- Keep work area clean and well lit.**  
Cluttered or dark areas invite accidents.
- Do not operate power tools in explosive atmospheres, such as in the presence of flammable liquids, gases or dust.** Power tools create sparks which may ignite the dust or fumes.
- Keep children and bystanders away while operating a power tool.** Distractions can cause you to lose control.

#### 2) ELECTRICAL SAFETY

- Power tool plugs must match the outlet. Never modify the plug in any way. Do not use any adapter plugs with earthed (grounded) power tools.** Unmodified plugs and matching outlets will reduce risk of electric shock.
- Avoid body contact with earthed or grounded surfaces such as pipes, radiators, ranges and refrigerators.** There is an increased risk of electric shock if your body is earthed or grounded.
- Do not expose power tools to rain or wet conditions.** Water entering a power tool will increase the risk of electric shock.
- Do not abuse the cord. Never use the cord for carrying, pulling or unplugging the power tool. Keep cord away from heat, oil, sharp edges or moving parts.** Damaged or entangled cords increase the risk of electric shock.
- When operating a power tool outdoors, use an extension cord suitable for outdoor use.** Use of a cord suitable for outdoor use reduces the risk of electric shock.
- If operating a power tool in a damp location is unavoidable, use a residual current device (RCD) protected supply.** Use of an RCD reduces the risk of electric shock.

#### 3) PERSONAL SAFETY

- Stay alert, watch what you are doing and use common sense when operating a power tool. Do not use a power tool while you are tired or under the influence of drugs, alcohol or medication.** A moment of inattention while operating power tools may result in serious personal injury.
- Use personal protective equipment. Always wear eye protection.** Protective equipment such as dust mask, non-skid safety shoes, hard hat, or hearing protection used for appropriate conditions will reduce personal injuries.
- Prevent unintentional starting. Ensure the switch is in the off position before connecting to power source and/or battery pack, picking up or carrying the tool.** Carrying power tools with your finger on the switch or energising power tools that have the switch on invites accidents.
- Remove any adjusting key or wrench before turning the power tool on.** A wrench or a key left attached to a rotating

part of the power tool may result in personal injury.

- e) **Do not overreach. Keep proper footing and balance at all times.** This enables better control of the power tool in unexpected situations.
- f) **Dress properly. Do not wear loose clothing or jewellery. Keep your hair, clothing and gloves away from moving parts.** Loose clothes, jewellery or long hair can be caught in moving parts.
- g) **If devices are provided for the connection of dust extraction and collection facilities, ensure these are connected and properly used.** Use of dust collection can reduce dust-related hazards.

#### 4) POWER TOOL USE AND CARE

- a) **Do not force the power tool. Use the correct power tool for your application.** The correct power tool will do the job better and safer at the rate for which it was designed.
- b) **Do not use the power tool if the switch does not turn it on and off.** Any power tool that cannot be controlled with the switch is dangerous and must be repaired.
- c) **Disconnect the plug from the power source and/or the battery pack from the power tool before making any adjustments, changing accessories, or storing power tools.** Such preventive safety measures reduce the risk of starting the power tool accidentally.
- d) **Store idle power tools out of the reach of children and do not allow persons unfamiliar with the power tool or these instructions to operate the power tool.** Power tools are dangerous in the hands of untrained users.
- e) **Maintain power tools. Check for misalignment or binding of moving parts, breakage of parts and any other condition that may affect the power tool's operation. If damaged, have the power tool repaired before use.** Many accidents are caused by poorly maintained power tools.
- f) **Keep cutting tools sharp and clean.** Properly maintained cutting tools with sharp cutting edges are less likely to bind and are easier to control.
- g) **Use the power tool, accessories and tool bits etc., in accordance with these instructions taking into account the working conditions and the work to be performed.** Use of the power tool for

operations different from those intended could result in a hazardous situation.

#### 5) BATTERY TOOL USE AND CARE

- a) **Recharge only with the charger specified by the manufacturer.** A charger that is suitable for one type of battery pack may create a risk of fire when used with another battery pack.
- b) **Use power tools only with specifically designated battery packs.** Use of any other battery packs may create a risk of injury and fire.
- c) **When battery pack is not in use, keep it away from other metal objects like paper clips, coins, keys, nails, screws or other small metal objects that can make a connection from one terminal to another.** Shorting the battery terminals together may cause burns or a fire.
- d) **Under abusive conditions, liquid may be ejected from the battery, avoid contact. If contact accidentally occurs, flush with water. If liquid contacts eyes, additionally seek medical help.** Liquid ejected from the battery may cause irritation or burns.

#### 6) SERVICE

- a) **Have your power tool serviced by a qualified repair person using only identical replacement parts.** This will ensure that the safety of the power tool is maintained.

### Additional Specific Safety Rules for Drill/Driver/Hammerdrill

- **Wear ear protectors when impact drilling.** Exposure to noise can cause hearing loss.
- **Use auxiliary handle(s), if supplied with the tool.** Loss of control can cause personal injury.
- **Hold power tool by insulated gripping surfaces, when performing an operation where the cutting accessory may contact hidden wiring.** Cutting accessory contacting a "live" wire may make exposed metal parts of the power tool "live" and could give the operator an electric shock.
- **Use clamps or other practical way to secure and support the workpiece to a stable platform.** Holding the work by hand or against your body is unstable and may lead to loss of control.
- **Wear safety goggles or other eye protection.** Hammering and drilling operations cause chips to fly. Flying particles can cause permanent eye

damage.

- **Accessories and tool may get hot during operation.** Wear gloves when handling them if performing heat producing applications such as hammerdrilling and drilling metals.
- **Do not operate this tool for long periods of time.** Vibration caused by hammer action may be harmful to your hands and arms. Use gloves to provide extra cushion and limit exposure by taking frequent rest periods.
- **Air vents often cover moving parts and should be avoided.** Loose clothes, jewelry or long hair can be caught in moving parts.

## Residual Risks

The following risks are inherent to the use of drills:

- Injuries caused by touching the rotating parts or hot parts of the tool.

In spite of the application of the relevant safety regulations and the implementation of safety devices, certain residual risks cannot be avoided. These are:

- Impairment of hearing.
- Risk of squeezing fingers when changing accessories.
- Health hazards caused by breathing dust developed when working in wood.
- Risk of personal injury due to flying particles.
- Risk of personal injury due to prolonged use.

## Markings on Tool

The following pictograms are shown on the tool:



Read instruction manual before use.

### DATE CODE POSITION (FIG. 1)

The Date Code (j), which also includes the year of manufacture, is printed into the housing surface that forms the mounting joint between tool and battery.

Example:

2014 XX XX

Year of Manufacture

## Important Safety Instructions for All Battery Chargers

**SAVE THESE INSTRUCTIONS:** This manual contains important safety and operating instructions for the DCB107 battery chargers.

- Before using the charger, read all instructions

and cautionary markings on charger, battery pack and product using the battery pack.



**WARNING:** Shock hazard. Do not allow any liquid to get inside charger. Electric shock may result.



**CAUTION:** Burn hazard. To reduce the risk of injury, charge only DeWALT rechargeable battery packs. Other types of batteries may overheat and burst resulting in personal injury and property damage.



**CAUTION:** Children should be supervised to ensure that they do not play with the appliance.

**NOTICE:** Under certain conditions, with the charger plugged in to the power supply, the exposed charging contacts inside the charger can be shorted by foreign material. Foreign materials of a conductive nature such as, but not limited to, steel wool, aluminum foil or any buildup of metallic particles should be kept away from charger cavities. Always unplug the charger from the power supply when there is no battery pack in the cavity. Unplug charger before attempting to clean.

- **DO NOT attempt to charge the battery pack with any chargers other than the ones in this manual.** The charger and battery pack are specifically designed to work together.
- **These chargers are not intended for any uses other than charging DEWALT rechargeable batteries.** Any other uses may result in risk of fire, electric shock or electrocution.
- **Do not expose charger to rain or snow.**
- **Pull by plug rather than cord when disconnecting charger.** This will reduce risk of damage to electric plug and cord.
- **Make sure that cord is located so that it will not be stepped on, tripped over or otherwise subjected to damage or stress.**
- **Do not use an extension cord unless it is absolutely necessary.** Use of improper extension cord could result in risk of fire, electric shock or electrocution.
- **When operating a charger outdoors, always provide a dry location and use an extension cord suitable for outdoor use.** Use of a cord suitable for outdoor use reduces the risk of electric shock.
- **Do not block the ventilation slots on the charger. The ventilation slots are located**



**on the top and sides of the charger.** Place the charger in a position away from any heat source.

- **Do not operate charger with damaged cord or plug** — have them replaced immediately.
- **Do not operate charger if it has received a sharp blow, been dropped or otherwise damaged in any way.** Take it to an authorised service centre.
- **Do not disassemble the charger; take it to an authorised service centre when service or repair is required.** Incorrect reassembly may result in a risk of electric shock, electrocution or fire.
- **In case of damaged power supply cord the supply cord must be replaced immediately by the manufacturer, its service agent or similar qualified person to prevent any hazard.**
- **Disconnect the charger from the outlet before attempting any cleaning. This will reduce the risk of electric shock.** Removing the battery pack will not reduce this risk.
- **NEVER attempt to connect 2 chargers together.**
- **The charger is designed to operate on standard 230 V household electrical power. Do not attempt to use it on any other voltage.** This does not apply to the vehicular charger.

### SAVE THESE INSTRUCTIONS

## Chargers

The DCB107 charger accepts 10.8 V, 14.4 V and 18 V Li-ION (DCB121, DCB123, DCB125, DCB127, DCB140, DCB141, DCB142, DCB144, DCB145, DCB180, DCB181, DCB182, DCB183, DCB184 and DCB185) battery packs.

This charger requires no adjustment and is designed to be as easy as possible to operate.







## Charging Procedure (fig. 2)

1. Plug the charger into an appropriate 220-240V outlet before inserting the battery pack.
2. Insert the battery pack (g) into the charger, making sure the pack is fully seated in the charger. The red (charging) light will blink continuously indicating that the charging process has started.
3. The completion of charge will be indicated by the red light remaining ON continuously. The pack is fully charged and may be used at this time or left in the charger.

**NOTE:** To ensure maximum performance and life of Li-ION batteries, charge the battery pack fully before first use.

## Charging Process

Refer to the table below for the state of charge of the battery pack.

State of charge—DCB107	
 charging	— — — — — 
 fully charged	————— 
 hot/cold pack delay	— — — — — 

### HOT/COLD PACK DELAY (DCB107)

The DCB107 charger has a hot/cold delay feature. When the charger detects a battery that is hot, it automatically delays charging until the battery has cooled.

When the charger detects a battery that is cold, it automatically delays charging until the battery has warmed.

The red light will continue to blink, but a yellow indicator light will be illuminated during this operation. Once the battery has cooled, the yellow light will turn off and the charger will resume the charging procedure.

XR Li-ION tools are designed with an Electronic Protection System that will protect the battery against overloading, overheating or deep discharge.

The tool will automatically turn off if the Electronic Protection System engages. If this occurs, place the Li-ION battery on the charger until it is fully charged.

## Important Safety Instructions for All Battery Packs

When ordering replacement battery packs, be sure to include the catalog number and voltage.

The battery pack is not fully charged out of the carton. Before using the battery pack and charger, read the safety instructions below and then follow the charging procedures outlined.

### READ ALL INSTRUCTIONS

- **Do not charge or use the battery pack in explosive atmospheres, such as in the presence of flammable liquids, gases or dust.** Inserting or removing the battery pack from the charger may ignite the dust or fumes.
- **Never force the battery pack into charger. Do not modify the battery pack in any way to fit into a non-compatible charger as battery pack may rupture causing serious personal injury.**

- Charge the battery packs only in designated DEWALT chargers.
- **DO NOT** splash or immerse in water or other liquids.
- **Do not store or use the tool and battery pack in locations where the temperature may reach or exceed 40 °C (105 °F) (such as outside sheds or metal buildings in summer).**
- For best results, make sure the battery pack is fully charged before use.



**WARNING:** Never attempt to open the battery pack for any reason. If the battery pack case is cracked or damaged, do not insert it into the charger. Do not crush, drop or damage battery pack. Do not use a battery pack or charger that has received a sharp blow, been dropped, run over or damaged in any way (e.g., pierced with a nail, hit with a hammer, stepped on). Electric shock or electrocution may result. Damaged battery packs should be returned to the service centre for recycling.



**CAUTION:** When not in use, place tool on its side on a stable surface where it will not cause a tripping or falling hazard. Some tools with large battery packs will stand upright on the battery pack but may be easily knocked over.

**SPECIFIC SAFETY INSTRUCTIONS FOR LITHIUM ION (Li-ION)**

- **Do not incinerate the battery pack even if it is severely damaged or is completely worn out.** The battery pack can explode in a fire. Toxic fumes and materials are created when lithium ion battery packs are burned.
- **If battery contents come into contact with the skin, immediately wash the area with mild soap and water.** If the battery liquid gets into the eye, rinse water over the open eye for 15 minutes or until irritation ceases. If medical attention is needed, the battery electrolyte is composed of a mixture of liquid organic carbonates and lithium salts.
- **Contents of opened battery cells may cause respiratory irritation.** Provide fresh air. If symptoms persists, seek medical attention.



**WARNING:** Burn hazard. Battery liquid may be flammable if exposed to spark or flame.

**Battery Pack**

**BATTERY TYPE**

The DCD734 operates on 14.4 volt battery packs.

The DCD771 and DCD776 operate on 18 volt battery packs.

The DCB140, DCB142, DCB143, DCB144, DCB145, DCB180, DCB181, DCB182, DCB183, DCB184 or DCB185 battery packs may be used. Refer to **Technical Data** for more information.

**Storage Recommendations**

1. The best storage place is one that is cool and dry away from direct sunlight and excess heat or cold. For optimum battery performance and life, store battery packs at room temperature when not in use.
2. For long storage, it is recommended to store a fully charged battery pack in a cool, dry place out of the charger for optimal results.

**NOTE:** Battery packs should not be stored completely depleted of charge. The battery pack will need to be recharged before use.

**Labels on Charger and Battery Pack**

In addition to the pictographs used in this manual, the labels on the charger and the battery pack show the following pictographs:



Read instruction manual before use.



Charging.



Fully charged.



Hot/cold pack delay.



Problem pack or charger.



Problem powerline.



Do not probe with conductive objects.



Do not charge damaged battery packs.



Use only with DeWALT battery packs.  
Others may burst, causing personal injury and damage.



Do not expose to water.



Have defective cords replaced immediately.



Charge only between 4 °C and 40 °C.



Discard the battery pack with due care for the environment.



Do not incinerate the battery pack.



Charges Li-ION battery packs.



See **Technical Data** for charging time.



Only for indoor use.

## Package Contents

The package contains:

- 1 Drill/driver or 1 drill/driver/hammerdrill
- 1 Charger
- 1 Li-ION battery pack (C1 model)
- 2 Li-ION battery packs (C2 model)
- 3 Li-ION battery packs (C3 model)
- 1 Kitbox
- 1 Instruction manual

**NOTE:** Battery packs, chargers and kitboxes are not included with N-models.

- Check for damage to the tool, parts or accessories which may have occurred during transport.
- Take the time to thoroughly read and understand this manual prior to operation.

## Description (fig. 1)



**WARNING:** Never modify the power tool or any part of it. Damage or personal injury could result.

- a. Trigger switch
- b. Forward/reverse control button
- c. Torque adjustment collar
- d. Gear shifter

- e. Worklight
- f. Keyless chuck
- g. Battery pack
- h. Battery release button
- i. Main handle

## INTENDED USE

These drills/drivers/hammerdrills are designed for professional drilling, percussion drilling and screwdriving applications.

**DO NOT** use under wet conditions or in presence of flammable liquids or gases.

These drills/drivers/hammerdrills are professional power tools.

**DO NOT** let children come into contact with the tool. Supervision is required when inexperienced operators use this tool.

- This product is not intended for use by persons (including children) suffering from diminished physical, sensory or mental abilities; lack of experience, knowledge or skills unless they are supervised by a person responsible for their safety. Children should never be left alone with this product.

## Electrical Safety

The electric motor has been designed for one voltage only. Always check that the battery pack voltage corresponds to the voltage on the rating plate. Also make sure that the voltage of your charger corresponds to that of your mains.



Your DeWALT charger is double insulated in accordance with IEC 60335; therefore no earth wire is required.

If the supply cord is damaged, it must be replaced by a specially prepared cord available through the DeWALT service organisation.

## Using an Extension Cable

An extension cord should not be used unless absolutely necessary. Use an approved extension cable suitable for the power input of your charger (see **Technical Data**). The minimum conductor size is 1 mm<sup>2</sup>; the maximum length is 30 m.

When using a cable reel, always unwind the cable completely.

## ASSEMBLY AND ADJUSTMENTS



**WARNING:** To reduce the risk of serious personal injury, turn tool off and disconnect battery pack before making any adjustments or removing/installing attachments or accessories. An accidental start-up can cause injury.



**WARNING:** Use only DEWALT battery packs and chargers.

### Inserting and Removing the Battery Pack from the Tool (fig. 2)



**WARNING:** Prior to assembly and adjustment, always remove the battery pack. Always switch off the tool before inserting or removing the battery pack.

**NOTE:** For best results, make sure your battery pack is fully charged.

#### TO INSTALL THE BATTERY PACK INTO THE TOOL HANDLE

1. Align the battery pack (g) with the rails inside the tool's handle (fig. 2).
2. Slide it into the handle until the battery pack is firmly seated in the tool and ensure that it does not disengage.

#### TO REMOVE THE BATTERY PACK FROM THE TOOL

1. Press the battery release button (h) and firmly pull the battery pack out of the tool handle.
2. Insert battery pack into the charger as described in the charger section of this manual.

#### FUEL GAUGE BATTERY PACKS (FIG. 2)

Some DEWALT battery packs include a fuel gauge which consists of three green LED lights that indicate the level of charge remaining in the battery pack.

To actuate the fuel gauge, press and hold the fuel gauge button (k). A combination of the three green LED lights will illuminate designating the level of charge left. When the level of charge in the battery is below the usable limit, the fuel gauge will not illuminate and the battery will need to be recharged.

**NOTE:** The fuel gauge is only an indication of the charge left on the battery pack. It does not indicate tool functionality and is subject to variation based on product components, temperature and end-user application.

### Variable Speed Trigger Switch (fig. 1)

To turn the tool on, squeeze the trigger switch (a). To turn the tool off, release the trigger switch. Your tool is equipped with a brake. The chuck will stop as soon as the trigger switch is fully released.

**NOTE:** Continuous use in variable speed range is not recommended. It may damage the switch and should be avoided.

### Forward/Reverse Control Button (fig. 1)

A forward/reverse control button (b) determines the direction of the tool and also serves as a lock-off button.

To select forward rotation, release the trigger switch and depress the forward/reverse control button on the right side of the tool.

To select reverse, depress the forward/reverse control button on the left side of the tool.

The center position of the control button locks the tool in the off position. When changing the position of the control button, be sure the trigger is released.

**NOTE:** The first time the tool is run after changing the direction of rotation, you may hear a click on start up. This is normal and does not indicate a problem.

### Torque Adjustment Collar (fig. 1)

Your tool has an adjustable torque screwdriver mechanism for driving and removing a wide array of fastener shapes and sizes and in some models, a hammer mechanism for drilling into masonry. Circling the collar (c) are numbers, a drill bit symbol, and on some models, a hammer symbol. These numbers are used to set the clutch to deliver a torque range. The higher the number on the collar, the higher the torque and the larger the fastener which can be driven. To select any of the numbers, rotate until the desired number aligns with the arrow.

### Dual Range Gearing (fig. 1)

The dual range feature of your drill/driver/hammerdrill allows you to shift gears for greater versatility.

1. To select speed 1 (high torque setting), turn the tool off and permit it to stop. Slide the gear shifter (d) forward (towards the chuck).
2. To select speed 2 (low torque setting), turn the tool off and permit it to stop. Slide the gear shifter back (away from the chuck).

**NOTE:** Do not change gears when the tool is running. Always allow the drill to come to a complete stop before changing gears. If you are having trouble changing gears, make sure that the dual range gear shifter is either completely pushed forward or completely pushed back.

## Worklight (fig. 1)

There is a worklight (e) located just above the trigger switch (a). The worklight is activated when the trigger switch is depressed. When the trigger is released, the worklight will stay illuminated for up to 20 seconds.

**NOTE:** The worklight is for lighting the immediate work surface and is not intended to be used as a flashlight.

## Keyless Single Sleeve Chuck (fig. 7–9)



**WARNING:** Do not attempt to tighten drill bits (or any other accessory) by gripping the front part of the chuck and turning the tool on. Damage to the chuck and personal injury may result. Always lock off trigger switch and disconnect tool from power source when changing accessories.



**WARNING:** Always ensure the bit is secure before starting the tool. A loose bit may eject from tool causing possible personal injury.

Your tool features a keyless chuck (f) with one rotating sleeve for one-handed operation of the chuck. To insert a drill bit or other accessory, follow these steps.

1. Turn tool off and disconnect tool from power source.
2. Grasp the black sleeve of the chuck with one hand and use the other hand to secure the tool. Rotate the sleeve counterclockwise far enough to accept the desired accessory.
3. Insert the accessory about 19 mm (3/4") into the chuck and tighten securely by rotating the chuck sleeve clockwise with one hand while holding the tool with the other. Your tool is equipped with an automatic spindle lock mechanism. This allows you to open and close the chuck with one hand.

Be sure to tighten chuck with one hand on the chuck sleeve and one hand holding the tool for maximum tightness.

To release the accessory, repeat steps 1 and 2 above.

## OPERATION

### Instructions for Use



**WARNING:** Always observe the safety instructions and applicable regulations.



**WARNING:** To reduce the risk of serious personal injury, turn tool off and disconnect battery pack before making any adjustments or removing/installing attachments or accessories. An accidental start-up can cause injury.

### Proper Hand Position (fig. 3)



**WARNING:** To reduce the risk of serious personal injury, **ALWAYS** use proper hand position as shown.



**WARNING:** To reduce the risk of serious personal injury, **ALWAYS** hold securely in anticipation of a sudden reaction.

Proper hand position requires one hand on the top of the drill as shown, with the other hand on the main handle (i).

### Screwdriver Operation (fig. 4)

1. Select the desired speed/torque range using the dual range gear selector to match the speed and torque of the planned operation.
2. Turn the torque adjustment collar (c) to the desired position. Lower numbers indicate lower torque settings; higher numbers indicate higher torque settings.
3. Insert the desired fastener accessory into the chuck as you would any drill bit.
4. Make some practice runs in scrap or on unseen areas to determine the proper position of the clutch collar.
5. Always start with lower torque settings, then advance to higher torque settings to avoid damage to the workpiece or fastener.

### Drill Operation (fig. 5)



**WARNING:** To reduce the risk of serious personal injury, turn tool off and disconnect tool from power source before making any adjustments or

removing/installing attachments or accessories.



**WARNING: To reduce the risk of personal injury, ALWAYS ensure workpiece is anchored or clamped firmly. If drilling thin material, use a wood "back-up" block to prevent damage to the material.**

1. Turn the collar (c) to the drill symbol.
2. Select the desired speed/torque range using the gear shifter to match the speed and torque to the planned operation.
3. For WOOD, use twist bits, spade bits, power auger bits or hole saws. For METAL, use high-speed steel twist drill bits or hole saws. Use a cutting lubricant when drilling metals. The exceptions are cast iron and brass which should be drilled dry.
4. Always apply pressure in a straight line with the bit. Use enough pressure to keep drill biting, but do not push hard enough to stall the motor or deflect the bit.
5. Hold tool firmly with both hands to control the twisting action of the drill. If model is not equipped with side handle, grip drill with one hand on the handle and one hand on the battery pack.



**CAUTION: Drill may stall if overloaded causing a sudden twist. Always expect the stall. Grip the drill firmly to control the twisting action and avoid injury.**

6. **IF DRILL STALLS**, it is usually because it is being overloaded or improperly used. **RELEASE TRIGGER IMMEDIATELY**, remove drill bit from work, and determine cause of stalling. **DO NOT CLICK TRIGGER ON AND OFF IN AN ATTEMPT TO START A STALLED DRILL – THIS CAN DAMAGE THE DRILL.**
7. To minimize stalling or breaking through the material, reduce pressure on drill and ease the bit through the last fractional part of the hole.
8. Keep the motor running when pulling the bit back out of a drilled hole. This will help prevent jamming.
9. With variable speed drills there is no need to center punch the point to be drilled. Use a slow speed to start the hole and accelerate by squeezing the trigger harder when the hole is deep enough to drill without the bit skipping out.

## Hammerdrill Operation (fig. 6)

### DCD776

1. Turn the collar (c) to the hammerdrill symbol.
2. Select the high speed setting by sliding the selector back (away from the chuck).  
**IMPORTANT:** Use carbide-tipped or masonry bits only.
3. Drill with just enough force on the hammer to keep it from bouncing excessively or "rising" off the bit. Too much force will cause slower drilling speeds, overheating and lower drilling rate.
4. Drill straight, keeping the bit at a right angle to the work. Do not exert side pressure on the bit when drilling as this will cause clogging of the bit flutes and a slower drilling speed.
5. When drilling deep holes, if the hammer speed starts to drop off, pull the bit partially out of the hole with tool still running to help clear debris from the hole.

**NOTE:** A smooth, even flow of dust from the hole indicates proper drilling rate.

## MAINTENANCE

Your DEWALT power tool has been designed to operate over a long period of time with a minimum of maintenance. Continuous satisfactory operation depends upon proper tool care and regular cleaning.



**WARNING: To reduce the risk of serious personal injury, turn tool off and disconnect battery pack before making any adjustments or removing/installing attachments or accessories. An accidental start-up can cause injury.**

The charger and battery pack are not serviceable. There are no serviceable parts inside.



## Lubrication

Your power tool requires no additional lubrication.



## Cleaning



**WARNING: Blow dirt and dust out of the main housing with dry air as often as dirt is seen collecting in and around the air vents. Wear approved eye protection and approved dust mask when performing this procedure.**



**WARNING:** *Never use solvents or other harsh chemicals for cleaning the non-metallic parts of the tool. These chemicals may weaken the materials used in these parts. Use a cloth dampened only with water and mild soap. Never let any liquid get inside the tool; never immerse any part of the tool into a liquid.*

#### CHARGER CLEANING INSTRUCTIONS



**WARNING:** *Shock hazard. Disconnect the charger from the AC outlet before cleaning. Dirt and grease may be removed from the exterior of the charger using a cloth or soft non-metallic brush. Do not use water or any cleaning solutions.*

#### Optional Accessories



**WARNING:** *Since accessories, other than those offered by DEWALT, have not been tested with this product, use of such accessories with this tool could be hazardous. To reduce the risk of injury, only DEWALT recommended accessories should be used with this product.*

Consult your dealer for further information on the appropriate accessories.

#### Protecting the Environment



Separate collection. This product must not be disposed of with normal household waste.



Should you find one day that your DEWALT product needs replacement, or if it is of no further use to you, do not dispose of it with household waste. Make this product available for separate collection.



Separate collection of used products and packaging allows materials to be recycled and used again. Re-use of recycled materials helps prevent environmental pollution and reduces the demand for raw materials.

Local regulations may provide for separate collection of electrical products from the household, at municipal waste sites or by the retailer when you purchase a new product.

DEWALT provides a facility for the collection and recycling of DEWALT products once they have reached the end of their working life. To take advantage of this service please return your product

to any authorised repair agent who will collect them on our behalf.

You can check the location of your nearest authorised repair agent by contacting your local DEWALT office at the address indicated in this manual. Alternatively, a list of authorised DEWALT repair agents and full details of our after-sales service and contacts are available on the Internet at: [www.2helpU.com](http://www.2helpU.com).



#### Rechargeable Battery Pack

This long life battery pack must be recharged when it fails to produce sufficient power on jobs which were easily done before. At the end of its technical life, discard it with due care for our environment:

- Run the battery pack down completely, then remove it from the tool.
- Li-ION cells are recyclable. Take them to your dealer or a local recycling station. The collected battery packs will be recycled or disposed of properly.

# 13 毫米 (1/2 英寸) 锂电充电式电钻起子/冲击钻

## DCD734、DCD771、DCD776

### 恭喜！

感谢您选购 DEWALT 工具。凭借多年的产品开发和创新能力，DEWALT 已经成为专业电动工具用户最可靠的合作伙伴之一。

### 技术参数

		DCD734	DCD771	DCD776
电压	伏特	14.4	18	18
型号		1	1	1
电池类型		锂离子	锂离子	锂离子
功率输出	瓦	250	300	300
空载转速				
1 档	转/分	0-400	0-450	0-450
2 档	转/分	0-1300	0-1500	0-1500
冲击率				
1 档	转/分	-	-	0-7650
2 档	转/分	-	-	0-25 500
最大扭矩 (硬/软)	牛米	38/22	42/24	42/24
夹头尺寸	毫米	13	13	13
最大钻孔能力				
木材	毫米	30	30	30
金属	毫米	10	13	13
砖石	毫米	-	-	13
重量 (不含电池组)	千克	1.2	1.3	1.34

电池组		DCB140	DCB141	DCB142	DCB143	DCB145
电池类型		锂离子	锂离子	锂离子	锂离子	锂离子
电压	伏特	14.4	14.4	14.4	14.4	14.4
电池容量	安时	3.0	1.5	4.0	2.0	1.3
重量	千克	0.53	0.30	0.54	0.30	0.30

电池组		DCB185	DCB181	DCB183	DCB180	DCB182
电池类型		锂离子	锂离子	锂离子	锂离子	锂离子
电压	伏特	18	18	18	18	18
电池容量	安时	1.3	1.5	2.0	3.0	4.0
重量	千克	0.35	0.35	0.40	0.64	0.61

充电器		DCB107				
电源电压	伏特	220				
电池类型		锂离子				
大约充电时间	分钟	60	70	90	140	185
		(1.3 安时电 组)	(1.5 安时电 组)	(2.0 安时电 组)	(3.0 安时电 组)	(4.0 安时电 组)
重量	千克	0.49				



## 定义：安全指引

下列定义描述了各警示词的严重程度。请仔细阅读这本手册，并注意这些警示符号。



**危险：**表示存在紧急危险情况，如果不加以避免，将导致死亡或严重伤害。



**警告：**表示存在潜在的危险情况，如果不加以避免，可能导致死亡或严重伤害。



**警示：**表示存在潜在危险情况，如果不加以避免，可能导致轻度或中度伤害。

**注意：**表示存在不涉及人身伤害的情况，如果不加以避免，可能导致财产损失。



表示存在触电风险。



表示存在火灾风险。



**警告：**为降低伤害风险，请阅读使用手册。

## 电动工具通用安全警告



**警告！**阅读随电动工具提供的所有安全警告、说明、图示和规定。不遵照以下所列说明会导致电击、着火和/或严重伤害。

**保存所有警告和说明书以备查阅。**

警告中的术语“电动工具”指市电驱动（有线）电动工具或电池驱动（无线）电动工具。

### a) 工作场地的安全

- 1) 保持工作场地清洁和明亮。混乱和黑暗的场地会引发事故。
- 2) 不要在易爆环境，如有易燃液体、气体或粉尘的环境下操作电动工具。电动工具产生的火花会点燃粉尘或气体。
- 3) 操作电动工具时，远离儿童和旁观者。注意力不集中会使你失去对工具的控制。

### b) 电气安全

- 1) 电动工具插头必须与插座相配。绝不能以任何方式改装插头。需接地的电动工具不能使

用任何转换插头。未经改装的插头和相配的插座将降低电击风险。

- 2) 避免人体接触接地表面，如管道、散热片和冰箱。如果你身体接触接地表面会增加电击风险。
- 3) 不得将电动工具暴露在雨中或潮湿环境中。水进入电动工具将增加电击风险。
- 4) 不得滥用软线。绝不能用软线搬运、拉动电动工具或拔出其插头。使软线远离热源、油、锐边或运动部件。受损或缠绕的软线会增加电击风险。
- 5) 当在户外使用电动工具时，使用适合户外使用的延长线。适合户外使用的电线将降低电击风险。
- 6) 如果无法避免在潮湿环境中操作电动工具，应使用带有剩余电流装置（RCD）保护的电源。RCD的使用可降低电击风险。

### c) 人身安全

- 1) 保持警觉，当操作电动工具时关注所从事的操作并保持清醒。当你感到疲倦，或在有药物、酒精或治疗反应时，不要操作电动工具。在操作电动工具时瞬间的疏忽会导致严重人身伤害。
- 2) 使用个人防护装置。始终佩戴护目镜。防护装置，诸如适当条件下使用防尘面具、防滑安全鞋、安全帽、听力防护等装置能减少人身伤害。
- 3) 防止意外起动。在连接电源和/或电池包、拿起或搬运工具前确保开关处于关断位置。手指放在开关上搬运工具或开关处于接通时通电会导致危险。
- 4) 在电动工具接通之前，拿掉所有调节钥匙或扳手。遗留在电动工具旋转零件上的扳手或钥匙会导致人身伤害。
- 5) 手不要过分伸展。时刻注意立足点和身体平衡。这样能在意外情况下能更好地控制住电动工具。
- 6) 着装适当。不要穿宽松衣服或佩戴饰品。让你的头发和衣服远离运动部件。宽松衣服、佩饰或长发可能会卷入运动部件。
- 7) 如果提供了与排屑、集尘设备连接用的装置，要确保其连接完好且使用得当。使用集尘装置可降低尘屑引起的危险。

- 8) 不要因为频繁使用工具而产生的熟悉感而掉以轻心，忽视工具的安全准则。某个粗心的动作可能在瞬间导致严重的伤害。

#### d) 电动工具使用和注意事项

- 1) 不要勉强使用电动工具，根据用途使用合适的电动工具。选用合适的按照额定值设计的电动工具会使你工作更有效、更安全。
- 2) 如果开关不能接通或关断电源，则不能使用该电动工具。不能通过开关来控制的电动工具是危险的且必须进行修理。
- 3) 在进行任何调节、更换附件或贮存电动工具之前，必须从电源上拔掉插头和/或卸下电池包（如可拆卸）。这种防护性的安全措施降低了电动工具意外起动的风险。
- 4) 将闲置不用的电动工具贮存在儿童所及范围之外，并且不允许不熟悉电动工具和不了解这些说明的人操作电动工具。电动工具在未经培训的使用者手中是危险的。
- 5) 维护电动工具及其附件。检查运动部件是否调整到位或卡住，检查零件破损情况和影响电动工具运行的其他状况。如有损坏，应在使用前修理好电动工具。许多事故是由维护不良的电动工具引发的。
- 6) 保持切削刀具锋利和清洁。维护良好地有锋利切削刃的刀具不易卡住而且容易控制。
- 7) 按照使用说明书，并考虑作业条件和要进行的作业来选择电动工具、附件和工具的刀头等。将电动工具用于那些与其用途不符的操作可能会导致危险情况。
- 8) 保持手柄和握持表面干燥、清洁，不得沾有油脂。在意外的情况下，湿滑的手柄不能保证握持的安全和对工具的控制。

#### e) 电池式工具使用和注意事项：

- 1) 仅使用生产者规定的充电器充电。将适用于某种电池包的充电器用到其他电池包时可能会发生着火危险。
- 2) 仅使用配有专用电池包的电动工具。使用其他电池包可能会产生伤害和着火危险。
- 3) 当电池包不用时，将它远离其他金属物体，例如回形针、硬币、钥匙、钉子、螺钉或其他小金属物体，以防电池包一端与另一端连

接。电池组端部短路可能会引起燃烧或着火。

- 4) 在滥用条件下，液体可能会从电池组中溅出，应避免接触。如果意外碰到液体，用水冲洗。如果液体碰到了眼睛，还应寻求医疗帮助。从电池中溅出的液体可能会发生腐蚀或燃烧。
- 5) 不要使用损坏或改装过的电池包或工具。损坏或改装过的电池组可能呈现无法预测的结果，导致着火、爆炸或伤害。
- 6) 不要将电池包暴露于火或高温中。电池包暴露于火或高于130°C的高温中可能导致爆炸。

#### f) 维修

- 1) 让专业维修人员使用相同的备件维修电动工具。这将保证所维修的电动工具的安全。
- 2) 决不能维修损坏的电池包。电池包仅能由生产者或其授权的维修服务商进行维修。

## 电钻起子/冲击钻的附加安全细则

- 带耳罩进行冲击作业。暴露于噪声环境会导致失聪。
- 使用辅助手柄。失控会导致人身伤害。
- 工具使用前应得到适当支撑。由于工具输出转矩大，运行时没有适当支撑会失控导致人身伤害。
- 使用随工具提供的辅助手柄。操作失手会引起人身伤害。
- 当在钻削附件可能触及暗线的场合进行操作时，通过绝缘握持面握持工具。钻削附件碰到带电导线会使工具外露金属零件带电而使操作者遭受电击。
- 在紧固件可能触及暗线进行操作时，要通过绝缘握持面来握持工具。紧固件碰到带电导线会使工具外露的金属零件带电从而使操作者受到电击。
- 使用夹具或采取其它可行的方法，将工件固定、支撑到稳定的平台上。手持或用身体顶住工件都是不稳定的，会导致操作失控。
- 请佩戴安全护目镜或其他护目装备。冲击或钻孔会导致碎片飞散。飞散的颗粒会对眼睛造成永久性伤害。

- **附件和工具可能会在使用过程中发热。**如果进行放热应用（如冲击钻孔和金属钻孔），处理时请佩戴手套。
- **不要长时间操作此工具。**锤击操作导致的振动可能会伤害您的手部和手臂。使用手套提供额外缓冲，经常停下休息，限制使用时间。
- **通风口通常会盖住运动部件，应加以避免。**宽松衣服、佩饰或长发可能会卷入运动部件。

## 剩余风险

使用电钻时具有下列风险：

- 碰触工具的旋转部件或带热的部件会导致人身伤害。

尽管遵守了相关的安全法规并采用了安全装备，某些剩余风险仍然是无法避免的。这些风险包括：

- 听力损伤。
- 更换附件时扭伤手指的风险。
- 锯切木材时，吸入粉尘导致的健康危害。
- 飞溅颗粒造成的人身伤害风险。
- 长时间使用引起的人身伤害风险。

## 工具上的标记

工具上印有下列标志：



使用前请阅读使用手册。

### 日期码位置（图1）

连接工具和电池之间的机壳表面印有日期代码 (1)，日期代码包括制造年份。

示例：                   2014 XX XX  
                                  制造年份

## 针对所有电池充电器的安全说明

**请妥善保管好这些说明：** 本手册包含重要的 DCB107 电池充电器安全和操作说明。

- 使用充电器之前，请阅读所有说明和充电器、电池组以及电池组产品上的警示标记。



**警告：触电危险。**请勿让任何液体渗入充电器，否则会引起触电。



**警示：灼伤危险。**为了减少受伤的危险，只使用 DeWALT 充电式电池组充电。其他类型的电池可能会过热爆裂，并造成人身伤害和财产损失。



**警示：必须监督儿童，确保他们不将此设备当做玩具来玩。**

**注意：**在某些情况下，充电器连接电源时，异物可能会连接充电器内的外露充电接触点而造成短路。请勿让能导电的异物靠近充电器腔，这些异物包括但不限于钢棉、铝箔或任何金属颗粒的堆积物。充电器内没有电池组时，请断开充电器与电源的连接。清洗前，务必拔掉充电器。

- **请勿试图使用本手册指定的充电器以外的任何其他充电器为电池组充电。**充电器和电池组都是专门设计的，互相配合使用。
- **除了为 DeWALT 充电式电池充电以外，这些充电器都不能用于其他任何用途。**否则，可能会导致火灾、触电或电击。
- **请勿将充电器暴露于雨中或雪中。**
- **断开充电器时应拔下插头，切勿拉拽电线。**这将减少电源插头和电源线损坏的风险。
- **确保电源线布置在不易踩踏、踢绊、拉扯或会受到损坏或压力的位置。**
- **非绝对必要条件下禁止使用延长线。**使用延长线不当可能会导致火灾、触电或电击的危险。
- **户外操作充电器时，请务必提供一个干燥的地方，并使用适合户外使用的延长电线。**采用适合户外使用的电线可降低触电风险。
- **禁止堵塞充电器上的通风槽。**通风槽位于充电器的顶部和两侧。请把充电器放置在远离任何热源的地方。
- **禁止使用电源线或插头已损坏的充电器 - 请立即更换已损坏的充电器。**
- **如果充电器受到强烈重击、掉落或出现其他损坏情况，请不要使用充电器。**请将损坏的充电器送到授权维修中心维修。
- **请勿拆卸充电器，请将需要维修或修理的充电器送到授权维修中心。**重装不正确可能会导致触电、电击或火灾风险。

- 必须立即将已损坏的电源线交由制造商、服务代理或类似的合格人员进行更换以防止安全隐患。
- **清洁前，请先断开充电器和插座的连接，以降低触电风险。**取出电池组不会降低触电风险。
- **切勿**试图将两个充电器连接在一起。
- **充电器额定电压是标准 220 伏家用电压。请勿试图在任何其他电压下使用充电器。**此规则不适用于车载充电器。

**请妥善保管好这些说明**

## 充电器

DCB107 充电器适用于 10.8 伏、14.4 伏和 18 伏锂离子 (DCB121, DCB123, DCB125, DCB127, DCB140, DCB141, DCB142, DCB144, DCB145, DCB180, DCB181, DCB182, DCB183, DCB184 和 DCB185) 电池组。

此充电器专为简易操作而设计，因此无需做出任何调整。







## 充电程序 (图 2)

1. 插入电池组前请将充电器插入到相应的 220-240 伏插座。
2. 将电池组 (g) 插入到充电器中，确定电池组完全就位。红色 (充电中) 指示灯将不断闪烁，表示充电过程已经开始。
3. 红色灯持续亮起表示充电完成。此时电池组已完全充电，您可以使用电池组或将电池组留在充电器上。

**注：**为了确保锂离子电池的效能和使用寿命最大化，在首次使用电池组之前必须将其完全充电。

## 充电过程

关于电池组的充电状态，请参阅下表。

充电状态 - DCB107	
 充电中	
 已完全充电	
 热/冷电池组延迟	

## 热/冷电池组延迟 (DCB107)

DCB107 充电器具有热/冷延迟功能。当充电器检测到电池为热的时，它会自动延迟充电，直到电池冷却下来为止。

当充电器检测到电池为冷的时，它会自动延迟充电，直到电池稍变热为止。

红色指示灯会继续闪烁，但黄色指示灯在本次操作过程中会亮起。电池冷却后，黄色指示灯会熄灭，充电器将恢复充电程序。

XR 锂离子电池工具具有“电子保护系统”设计，可保护电池免受过载、过热或过度放电之害。

如果电子保护系统处于运作状态，该工具将自动停止操作。如果发生这种情况，请将锂离子电池放在充电器上直到完全充电。

## 针对所有电池组的重要安全说明

在订购更换电池组时，请务必附上目录号码和电压。

包装箱内的电池组并未完全充电。在使用电池组和充电器之前，请阅读下面的安全说明，然后按照所述充电程序进行操作。

### 请阅读所有说明

- **请勿在易爆环境中充电或使用电池组，如有易燃液体、气体或粉尘的环境。**在充电器中插入或取出电池组时可能会点燃粉尘或烟雾。
- **切勿将电池组强行插入充电器。不得以任何方式改装电池组并将电池组插入不兼容的充电器，这种操作可能会导致电池组破裂，并造成严重的人身伤害。**
- 只使用指定的 DeWALT 充电器为电池组充电。
- **请勿**喷溅电池组或将其浸泡在水或其他液体中。
- **禁止在温度可能达到或超过 40 °C (105 °F) 的地方 (如夏天户外的棚子或金属建筑物中) 存储或使用工具和电池组。**
- 为达到最佳效果，请确保电池组在使用前已完全充电。



**警告：**切勿以任何理由试图打开电池组。电池组外壳破裂或损坏时，不要将电池组插入充电器。不要挤压、掉落或损坏电池组。不要使用受过强烈重击、掉落、碾压或以其他方式（如被钉子穿破、受到锤子的重击、踩踏）受损的电池组或充电器，否则可能会引起触电或电击。损坏的电池组应交回服务中心进行回收。



**警告：**不用时，将工具侧放在平稳的表面上，确保不会有踢绊或掉落的危险。一些具有大型电池组的工具将直立于电池组之上，但可能会轻易被撞倒。

### 锂离子电池的安全说明

- **即使电池组已经严重受损或已完全耗竭也不可焚烧处理电池组。** 电池组会在火中会发生爆炸。锂离子电池组在燃烧时会释放有毒气体和物质。
- **如果皮肤接触到电池内含物质，请立即用温和肥皂和水冲洗接触的地方。** 如果电池液进入眼睛，应睁开眼睛用清水冲洗至少 15 分钟或直到刺激感消失。  
如果需要医疗救助，请告知医护人员。电池电解质是由液状有机碳酸盐和锂盐的混合物组成。
- **已打开电池的內部物质可能会导致呼吸道刺激。** 请保持空气流通。如果症状持续存在，请寻求医疗帮助。



**警告：**灼伤危险。电池液如果接触到火花或火焰就有可能燃烧。

## 电池组

### 电池类型

DCD734 使用 14.4 伏特电池组。

DCD771 和 DCD776 使用 18 伏特电池组。

DCB140, DCB142, DCB143, DCB144, DCB145, DCB180, DCB181, DCB182, DCB183, DCB184 或

DCB185 的电池组也可以使用。更多信息，请参阅 **技术参数**。

## 存放建议

1. 最好将电池存放在阴凉、干燥、远离阳光直射、不会过热或过冷的地方。为了获得最佳的电池性能和使用寿命，请您在不使用电池组时将其存储在室温下。
2. 长期存储时，建议将完全充电的电池组从充电器取出，存储在阴凉、干燥的地方，以达到最佳效果。

**注：**电池组不应在电池已完全耗尽的状态下存放。使用电池组之前，必须重新为电池组充电。

## 充电器和电池组上的标签

除了在本手册中所使用的标志，充电器和电池组的标签还包括：



使用前请阅读使用手册。



充电中。



已完全充电。



热/冷电池组延迟。



电池组或充电器故障。



电源线故障。



请勿使用导电物体碰触。



请勿对已损坏的电池组充电。



DCB107 ✓

只使用 DeWALT 电池组。其他电池组可能会爆炸，导致人身伤害和损坏。



请勿将其暴露于水中。



电线故障，请立即更换。



只在温度介于 4 °C 至 40 °C 之间充电。



弃置电池组时，请妥善处理以保护我们的环境。



请勿焚烧电池组。



锂离子电池组充电。



有关充电时间，请参阅 **技术参数**。



只能在室内使用。

## 包装内的物品

本产品包装内的物品有：

- 1 电钻/起子或 1 个电钻/起子/冲击钻
- 1 充电器
- 1 锂离子电池组 (C1 型号)
- 2 锂离子电池组 (C2 型号)
- 3 锂离子电池组 (C3 型号)
- 1 工具箱
- 1 使用手册

**注：**N 型号不包括电池组、充电器和工具箱。

- 检查工具、部件或附件是否在运输过程中损坏。
- 操作前，请抽空仔细阅读并掌握本手册。

## 描述 (图 1)



**警告：**切勿改装电动工具或其任何部件，否则可能会导致损坏或人身伤害。

- a. 触发开关

- b. 正转/反转控制按钮
- c. 扭矩调节轴环
- d. 换档器
- e. 工作灯
- f. 自紧式夹头
- g. 电池组
- h. 电池释放按钮
- i. 主手柄

## 设计用途

这些电钻/起子/冲击钻设计用于专业钻孔、冲击钻孔和螺丝安装。

**请勿**在潮湿环境中或在有易燃液体或气体的环境中使用。

这些电钻/起子/冲击钻是专业型电动工具。

**请勿**让儿童接触本工具。缺乏经验的操作人员需要在监督下使用本工具。

- 本产品不适合体力、感官或智力不足以及缺乏经验、知识或技能的人员（包括儿童）使用，除非一旁有能为他们的安全负责的监督人员。不得在无人监管的情况下让儿童触及本产品。

## 电气安全

电机只适用一种工作电压。请务必检查电池组的电压是否和铭牌上的电压一致。另外，请确保充电器电压和主电源的电压一致。



您的 DeWALT 充电器符合 IEC 60335 双重绝缘要求，因此无需使用接地线。

若电源线损坏，必须交由 DeWALT 服务部门采用专门制备的电线进行更换。

## 使用延长电缆

除非绝对必要，否则请勿使用延长线。使用适合您的充电器电源输入的合格延长线（见 **技术参数**）。最小的导线尺寸为 1 mm<sup>2</sup>；最大长度为 30 m。

使用电缆卷筒时，请务必拉出所有的电缆。

## 组装和调整



**警告：为降低严重的人身伤害风险，在进行任何调整或取出/安装附加装置或附件之前，请关闭工具并断开电池组连接。意外启动可能会导致人身伤害。**



**警告：只使用 DeWALT 电池组和充电器。**

## 插入和取出工具上的电池组（图 2）



**警告：组装与调整之前，请务必取出电池组。插入或取出电池组之前，请务必关闭工具。**

**注：**为达到最佳效果，请确保电池组在使用前完全充电。

### 将电池组安装到工具手柄中

1. 将电池组 (g) 对齐工具手柄内的轨道（图 2）。
2. 将电池组滑入手柄内，使其牢牢地固定在工具内，并确保不会脱落。

### 从工具中取出电池组

1. 按电池释放按钮 (h)，并用力将电池组从工具手柄中拉出。
2. 按本手册充电器部分所述将电池组插入充电器中。

### 电池组电量计（图 2）

一些 DeWALT 电池组带有一个包含三个绿色 LED 指示灯的电量计，用于指示电池组内的剩余电量。若要启动电量计，请按下电量计按钮 (k) 不要松开。三个绿色 LED 指示灯将以组合方式亮起，以指示剩余电量。当电池内的电量低于可用限制时，电量计将不会亮起，电池将需要重新充电。

**注：**电量计仅指示电池组的剩余电量。它并不表示该工具的功能性能，且将根据产品组件、温度和最终用户的使用情况而有所不同。

## 变速触发开关（图 1）

若要开启工具，请按压触发开关 (a)。若要关闭工具，请松开触发开关。您的工具配备制动器。触发开关完全松开时夹头将停止运作。

**注：**不建议在变速范围内连续使用工具。否则可能会损坏开关，因此应尽量避免。

## 正转/反转控制按钮（图 1）

正转/反转控制按钮 (b) 可确定工具方向，同时具有锁定按钮的功能。

若要选择正向旋转，请松开触发开关，然后按下工具右侧的正转/反转控制按钮。

若要选择反向旋转，请按下工具左侧的正转/反转控制按钮。

控制按钮的中心位置会将工具锁定在关闭位置。改变控制按钮的位置时，确保触发开关处于松开状态。

**注：**改变旋转方向后第一次运行工具时，您可能在启动时听到“咔哒声”。这是正常现象，并不表示出现问题。

## 扭矩调节轴环（图 1）

您的工具配备一个可调节的扭矩螺丝起子装置，用于安装和取出各种形状和大小的紧固件，而且在某些型号中还配备一个锤击装置，用于砖石钻孔。轴环 (c) 的周围是编号和钻头符号，在某些型号中，还有冲击钻符号。这些编号用于设置离合器以提供扭矩范围。轴环上的编号越大，扭矩越高，并且可安装的紧固件也越大。若要选择任一编号，请旋转轴环直到所需的编号与箭头对齐。

## 双速排挡（图 1）

电钻/起子/冲击钻的双速功能可换挡以获得更大的适用性。

1. 若要选择速度 1（高扭矩设置），请关闭工具并让它停止转动。将换挡器 (d) 尽量向前滑动（滑向夹头）。
2. 若要选择速度 2（低扭矩设置），请关闭工具并让它停止转动。将换挡器尽量向后滑动（远离夹头）。

**注：**工具在运行时切勿换挡。在换挡之前，务必等待电钻完全停止。如果无法换挡，请确保双速换挡器已完全向前推动或完全向后推动。

## 工作灯（图 1）

工作灯 (e) 位于触发开关 (a) 正上方。工作灯将在按压触发开关时启动。松开触发开关后，工作灯最长将延迟 20 秒。

**注：**工作灯是用于照亮紧邻的工作表面，不能当作手电筒使用。

## 无钥匙式夹头（图 7-9）



**警告：**请勿试图通过握住夹头前端和打开工具来拧紧钻头（或任何其他附件）。这可能会导致夹头损坏和人身伤害。更换附件时，始终锁定触发开关并断开工具的电源连接。



**警告：**启动工具之前应确保钻头安装稳固。松动的钻头可能会从工具脱落，从而可能导致人身伤害。

您的工具配备自紧式夹头 (f)，带有一个旋转套管，便于单手操作夹头。若要插入钻头或其他附件，请执行下列步骤。

1. 关闭工具并断开工具的电源连接。
2. 用一只手抓住夹头的黑色套管，用另一只手固定工具。逆时针旋转套管以接受所需的附件。
3. 将附件插入夹头约 19 毫米 (3/4") 处，然后用一只手顺时针旋转夹头，另一只手则握住工具，将附件拧紧。您的工具配备一个自动主轴

锁装置。凭借此装置，您只需一只手即可打开和关闭夹头。

确保在拧紧夹头时用一只手握住夹头套管，用另一只手握住工具，以获得最大的紧密性。

若要松开附件，请重复上述步骤 1 和 2。

## 操作

### 使用说明



**警告：**请务必遵守安全指示和适用法规。



**警告：**为降低严重的人身伤害风险，在进行任何调整或取出/安装附加装置或附件之前，请关闭工具并断开电池组连接。意外启动可能会导致人身伤害。

### 正确的手持方式（图 3）



**警告：**为降低严重的人身伤害风险，请务必使用正确的手持方式，如图所示。



**警告：**为降低严重的人身伤害风险，请务必紧握工具以防止意外事件。

正确的手持方式要求一只手握住电钻顶端（如图所示），另一只手则握住主手柄 (i)。

### 螺丝起子操作（图 4）

1. 使用双速档位选择器选择所需的速度/扭矩范围以满足操作计划的速度和扭矩要求。
2. 将扭矩调节轴环 (c) 转至所需位置。编号越小，表示扭矩设置值越小；编号越大，表示扭矩设置值越大。
3. 将所需的紧固件附件插入任意钻头的夹头。
4. 在较小或隐蔽区域进行一些实际运行以确定夹头轴环的正确位置。
5. 务必先从较低的扭矩设置开始，然后再使用较高的扭矩设置以避免损坏工件或紧固件。



## 电钻操作 (图 5)



**警告：**为降低严重的人身伤害风险，在进行任何调整或取出/安装附加装置或附件之前，请关闭工具并断开工具电源连接。



**警告：**为降低人身伤害风险，请始终牢固锚定或夹紧工件。如果在较薄材料上钻孔，请使用“垫板”以防止损坏材料。

1. 将轴环 (c) 转至电钻符号。
2. 使用换挡器选择所需的速度/扭矩范围以满足操作计划的速度和扭矩要求。
3. 钻木材时，应使用麻花钻头、扁钻头、机械螺旋钻头或孔锯。钻金属时，应使用高速钢麻花钻头或孔锯。在金属上钻孔时，请使用切削润滑剂。但铸铁和黄铜材料例外，应干钻。
4. 用力方向始终与钻头成一直线。请施加足够的压力，保证钻进所需，但不要大到马达失速或钻头倾斜。
5. 请双手紧握电钻，控制电钻的扭转效应。如果该型号不带侧手柄，请用一只手抓紧电钻手柄，另一只手则抓住电池组。



**警告：**如果过载，电钻可能会失速，从而导致突然扭转。务必预计是否会发生失速。紧握电钻以控制扭转效应，避免伤害。

6. 如果电钻失速，通常是由于过载或使用不当所致。请立即松开触发开关，从工件上退出钻头，查找失速的原因。切勿试图通过按下、松开触发开关来启动失速的电钻 - 这会损坏电钻。
7. 为尽量减少失速故障或避免钻头在材料中折断，请降低对电钻的压力，使钻头从孔的最后部分中缓和下来。
8. 从成孔中拉出钻头时，请保持马达运转。这有助于防止卡死。

9. 使用变速电钻时，无需中心冲定位。启动时采用较低速度，当钻深足以防止跳钻时，加力挤压触发开关，使电钻加速。

## 冲击钻操作 (图 6)

### DCD776

1. 将轴环 (c) 转至电钻符号。
  2. 向后滑动选择器（远离夹头），选择高速设置。
- 重要信息：**只使用碳化钻头或砖石钻头。
3. 钻孔时，只需对锤子施加足够的力，以防止过度反弹或“脱离”钻头。过多压力将导致钻孔速度变慢，过热，钻孔速度降低。
  4. 直线钻孔，保持钻头与工件成直角。钻孔时不要在钻头上施加侧压力，这将导致钻头凹槽阻塞和钻孔速度变慢。
  5. 钻深孔时，如果锤子速度开始减慢，在工具仍运行的情况下，从孔中拔出部分钻头以帮助清理钻屑。

**注：**如果钻屑平滑、均匀地流出，则表明钻孔速度适当。

## 维护

DEWALT 电动工具设计精良，可以长期使用，而且只需最少的维护。要连续获得令人满意的工作效果，需要进行合适的工具维护和定期清洁。



**警告：**为降低严重的人身伤害风险，在进行任何调整或取出/安装附加装置或附件之前，请关闭工具并断开电池组连接。意外启动可能会导致人身伤害。

充电器和电池组无法维修。这些组件内没有可以维修的部件。



## 润滑

本电动工具无需另行润滑。



## 清洁



**警告：**一旦通风口和周围积聚了可见的粉尘，请立即用干燥的空气吹走主机外壳内的粉尘和灰尘。执行此过程时，需戴上经认可的护目装备和防尘面具。



**警告：**切勿使用溶剂或其他刺激性化学制品来清洁工具的非金属部件。这些化学物质可能会削弱这些部件使用的材料。请用布蘸温和的肥皂水擦拭。切勿让任何液体渗入工具，切勿让工具的任何部分浸在液体中。

### 充电器清洁说明



**警告：**触电危险。清洁前，请将充电器从交流电源插座上拔下。可用布或非金属软刷清除充电器外部的污垢和油脂。请勿使用水或任何清洁剂。

## 可选附件



**警告：**由于非 DeWALT 供应的附件未经本产品匹配测试，将此类附件用于本工具可能会造成危险。为降低伤害风险，本产品只可使用 DeWALT 推荐的附件。

请向您的经销商咨询更多关于合适附件的信息。

## 保护环境



分类回收。本产品不得与普通家庭垃圾一起处理。

如果您发现您的 DeWALT 产品需要更换或您已经不再需要使用这些产品，请不要将它们与家庭垃圾一起处理。请将它们单独分类回收。



分类回收使用过的产品和包装能够让材料得以再循环和再利用。回收材料的再利用有助于防止环境污染，并降低对原材料的需求。

当地法规可能要求由市政废物处理点或向您出售新产品的零售商提供从家庭中分类回收电气产品的服务。

DeWALT 提供设施收集和回收使用寿命到期的 DeWALT 产品。若要享受这项服务，请将产品送回任一授权维修代理，他们将代表我们回收您的产品。

您可通过联系本手册中所记载的当地 DeWALT 办事处查询离您最近的授权维修代理的位置。您也可以通过网络获取 DeWALT 授权维修代理名单以及我们售后服务与联络人的完整详情，网址为：[www.2helpU.com](http://www.2helpU.com)。



## 充电式电池组

本电池组使用寿命长，不能提供顺利完成工作所需的电力时，必须进行充电。电池技术寿命结束时，请妥善处理以保护我们的环境。

- 耗尽电池组的电力，然后从工具上拆下。
- 锂离子电池是可回收的。将它们送往您的经销商处或当地的回收站。回收的电池组将被妥善循环使用或处理。

**制造商：** 百得德国公司

**地址：** Black & Decker Str.40 65510 Idstein, 德国

**产地：** 江苏苏州

# 13MM (1/2") 充電式電鑽/震動電鑽調扭起子機

## DCD734、DCD771、DCD776

### 恭喜閣下！

感謝您選購 DEWALT 工具。憑藉多年的產品開發和創新經驗，DEWALT 已成為專業電動工具使用者最信賴的夥伴之一。

### 技術資料

		DCD734	DCD771	DCD776
電壓	$V_{DC}$	14.4	18	18
類型		1	1	1
電池類型		鋰離子電池	鋰離子電池	鋰離子電池
功率輸出	W	250	300	300
空載速度				
1 檔	$\text{min}^{-1}$	0-400	0-450	0-450
2 檔	$\text{min}^{-1}$	0-1300	0-1500	0-1500
震動率				
1 檔	$\text{min}^{-1}$	–	–	0-7650
2 檔	$\text{min}^{-1}$	–	–	0-25 500
最大扭矩 (硬/軟)	Nm	38/22	42/24	42/24
夾頭尺寸	mm	13	13	13
最大鑽孔效能				
木材	mm	30	30	30
金屬	mm	10	13	13
磚石	mm	–	–	13
重量 (不包括電池組)	kg	1.2	1.3	1.34

電池組		DCB140	DCB141	DCB142	DCB143	DCB145
電池類型		鋰離子電池	鋰離子電池	鋰離子電池	鋰離子電池	鋰離子電池
電壓	$V_{DC}$	14.4	14.4	14.4	14.4	14.4
電池容量	$A_h$	3.0	1.5	4.0	2.0	1.3
重量	kg	0.53	0.30	0.54	0.30	0.30

電池組		DCB185	DCB181	DCB183	DCB180	DCB182
電池類型		鋰離子電池	鋰離子電池	鋰離子電池	鋰離子電池	鋰離子電池
電壓	$V_{DC}$	18	18	18	18	18
電池容量	$A_h$	1.3	1.5	2.0	3.0	4.0
重量	kg	0.35	0.35	0.40	0.64	0.61

充電器		DCB107				
電源電壓	$V_{AC}$	110 V				
電池類型		鋰離子電池				
大約充電時間	分鐘	60	70	90	140	180
		(1.3 Ah 電池組)	(1.5 Ah 電池組)	(2.0 Ah 電池組)	(3.0 Ah 電池組)	(4.0 Ah 電池組)
重量	kg	0.49				

## 定義：安全指南

以下定義描述了每一個詞彙的嚴重程度。請閱讀本手冊並注意這些符號。



**危險：**表示緊急危險情況，若未能避免，將導致**死亡或嚴重傷害**。



**警告：**表示潛在危險情況，若未能避免，可能導致**死亡或嚴重傷害**。



**小心：**表示潛在危險情況，若未能避免，可能導致**輕微或中度傷害**。

**注意：**表示一種**非人身傷害**的行為，若未能避免，可能導致**財產損失**。



表示觸電危險。



表示火災危險。



**警告：**為了降低受傷的風險，必須仔細閱讀使用手冊。

## 電動工具一般安全警告



**警告！**請閱讀所有安全警告及指示。不遵循這些警告和指示可能會導致觸電、火災及/或嚴重傷害。

**請妥善保存所有的警告和  
使用手冊以備將來查閱**

警告中的名詞「電動工具」是指電源驅動（插電）電動工具，或者電池驅動（充電）電動工具。

### 1) 工作場地安全

- 保持工作場地清潔和明亮。混亂或黑暗的場地會引發事故。
- 不要在易爆環境，如有易燃液體、氣體或塵埃的環境中操作電動工具。電動工具產生的火花可能會點燃粉塵或氣體。
- 請等待兒童和旁觀者離開之後才操作電動工具。分心會導致您疏於控制。

### 2) 電力安全

- 電動工具插頭必須與插座相符。請勿以任何方式改裝插頭。需接地的電動工具不能使用任何配接器插頭。未經改裝的插頭和相符的插座可以減少觸電危險。
- 避免人體接觸接地表面，如管道、散熱片、爐灶和冰箱。若您的身體接地，會增加觸電危險。
- 不得將電動工具暴露在雨中或潮濕環境中。水進入電動工具會增加觸電危險。
- 請勿濫用電線。請勿使用電線來搬運、拉動電動工具或拔出插頭。讓電線遠離熱、油、銳邊和活動部件。受損或纏繞的電線會增加觸電危險。
- 若要在戶外使用電動工具，請使用適合戶外使用的延長電線。使用適合戶外使用的電線可減少觸電危險。
- 若必須在潮濕場合使用電動工具，請使用漏電保護器 (RCD)。使用 RCD 可降低觸電危險。

### 3) 人身安全

- 保持警覺；在操作電動工具時，請留意所執行的操作並按照一般的常識執行。切勿在疲倦，或受到藥物、酒精或治療的影響下操作電動工具。操作電動工具期間注意力分散會導致嚴重人身傷害。
- 使用個人防護裝置。始終佩戴護目裝備。防護裝置，例如在適當條件下使用的防塵面具、防滑安全鞋、安全帽或聽力保護等裝置可減少人身傷害。
- 避免意外啟動。連接電源及/或電池組、舉抬或搬運電動工具之前，請確定開關處於關閉位置。搬運電動工具時若將手指放在開關上，或電動工具接通電源時開關處於開啟位置都會引發危險。
- 啟動電動工具之前，請卸下所有的調整鑰匙或扳手。遺留在電動工具旋轉部件上的扳手或鑰匙會導致人身傷害。

- e) **不要過度伸張雙手。時刻注意腳下和身體的平衡。**如此即可在發生意外的情況下更好地控制電動工具。
- f) **適當穿著。不要穿寬鬆衣服或佩戴飾品。讓您的頭髮、衣服和手套遠離活動部件。**寬鬆衣服、佩飾或長髮可能會捲入活動部件。
- g) **若配備用於連接排屑裝置、集塵設備的裝置，請確定正確連接和使用這些裝置。**使用集塵設備可減少與粉塵有關的危險。

#### 4) 電動工具的使用與維護

- a) **不要超負荷使用電動工具。根據您的用途使用適當的電動工具。**使用適當的電動工具在其設計可負荷的應用內，會讓您更有效、更安全地執行工作。
- b) **若開關不能開啟或關閉電源，請勿使用該電動工具。**不能用開關來控制的電動工具將存在危險，因此必須進行修理。
- c) **在執行任何調整、更換配件或儲存電動工具之前，請從電源上拔掉插頭及/或卸下電池組。**這類防護性安全措施可降低電動工具意外啟動的風險。
- d) **將閒置的電動工具儲存在兒童無法接觸的地方，並且不要讓不熟悉電動工具或對這些使用指示不瞭解的人員操作電動工具。**電動工具在未經培訓的使用者手中會發生危險。
- e) **維護電動工具。檢查活動部件是否對準或卡住、破損情況以及是否存在影響電動工具運行的其他情況。若有損毀，必須在使用之前修理電動工具。**許多事故都是由於電動工具欠缺維護所導致。
- f) **保持刀具鋒利和清潔。**妥善維護、切削鋒利的刀具不會輕易卡住並可更輕鬆控制。
- g) **使用電動工具、配件和工具刀頭等時，請遵循這些指示使用，且指示須包含工作環境和所要執行工作的注意事項。**不按照設計目的使用電動工具會導致危險。

#### 5) 電池工具的使用與注意事項

- a) **只能使用製造廠商指定的充電器為電池充電。**使用僅適合一種電池組的充電器為其他類型的電池組充電會導致火災危險。
- b) **請使用原廠的電動工具電池組。**使用其他非原廠的的電池組會導致人身傷害和火災危險。
- c) **不使用電池組時，請將其遠離如迴紋針、硬幣、鑰匙、釘子、螺絲以及其他可連通電池兩極的金屬物品。**將電池兩極短路會導致灼傷或火災。
- d) **濫用電池的情況下，液體會從電池中噴出，避免與液體接觸。若不小心接觸液體，請用清水沖洗。若液體噴濺到眼睛上，沖洗之後還要進行治療。**從電池噴出的液體會刺激皮膚或造成灼傷。

#### 6) 檢修

- a) **本電動工具必須由合格的維修人員並只採用相同的替換零件來執行檢修。**這樣將確保電動工具的安全。

### 電鑽/起子機/錘鑽之其他特殊安全規定

- **請在使用震動電鑽時佩戴聽力保護器。**噪音會使聽力受損。
- **請使用工具隨附的輔助手柄。**工具失控會導致人身傷害。
- **若在執行操作時切削配件可能會接觸隱藏的電線，請從絕緣手柄表面握住電動工具。**若切削配件接觸到「帶電」導線，電動工具金屬部件表面就會「帶電」，從而導致操作人員觸電。
- **使用夾具或採取其他可行的方法，將工件固定、支撐到穩定的平台上。**手持或用身體頂住工件都是不穩定的，並會導致操作失控。
- **請佩戴護目鏡或其他護目裝備。**錘擊和鑽孔會引致碎片飛散。飛散的顆粒可以對眼睛造成永久傷害。

- **配件和工具會在作業過程中變熱。**若進行放熱應用（如錘鑽或金屬鑽孔），處理時請佩戴手套。
- **切勿長時間操作此工具。**工具產生的震動可能令您的雙手和手臂受傷。請佩戴手套加強保護，而且經常稍作休息，減少承受的震力。
- **通風口通常會蓋住活動部件，應予以避免。**寬鬆衣服、佩飾或長髮可能會捲入活動部件。

## 剩餘風險

使用電鑽具有以下危險：

- 接觸工具的旋轉部件或高溫部件導致的傷害。

即使應用有關的安全規定並採用安全設備，仍然還有一些無法避免的剩餘風險。包括：

- 聽力受損。
- 更換配件時擠壓手指的危險。
- 在木材工作環境下產生的可吸入塵埃對健康的危害。
- 飛散的顆粒引起的人身傷害風險。
- 長時間使用引起的人身傷害風險。

## 工具上的標誌

工具上可能會附帶下列圖示：



使用前請閱讀使用手冊。

### 日期代碼位置 (圖 1)

日期代碼 (i) 也包括製造年份，已經印刷在工具外殼上電池安裝接口的表面上。

範例：

2014 XX XX

製造年份

## 所有電池充電器之重要安全指示

**請保存這些安全指示：**本手冊提供有關 DCB107 電池充電器的重要安全和操作指示。

- 在使用充電器之前，請先閱讀所有的指示以及充電器、電池組和採用電池組的產品上的警告標記。



**警告：**觸電危險。切勿讓任何液體進入充電器。否則可能會導致觸電。



**小心：**燒傷危險。為了減低受傷風險，僅可以使用 DeWALT 可再充電的電池組。其他非原廠電池可能會過熱爆裂，導致人身傷害和財產損失。



**小心：**必須監督小孩，確保他們沒有玩耍器具。

**註意：**在某些情況下，充電器連接到電源後，充電器內暴露的充電觸頭會被異物導致短路。導電的異物，包括但不限於鋼絲絨、鋁箔紙或任何由金屬粒子組成的物件，必須要遠離充電器範圍。充電器裡沒有電池組時，一定要拔掉充電器的電源。請先拔掉電源插頭後再清潔充電器。

- **切勿嘗試使用本手冊未提到的充電器替電池組充電。**充電器和電池組是為了一同使用而特別設計。
- **除了為 DeWALT 可充電的電池充電之外，這些充電器不可以用於其他用途。**否則可能會導致火災、觸電或觸電致死。
- **切勿把充電器暴露在雨、雪之中。**
- **中斷充電器的電源時，請拔除插頭而非拉扯電線。**這樣會減低電源插頭和電線損壞的風險。
- **請確保電線的位置不會被踐踏、令人絆倒，或引起其他方式的損壞或受壓。**
- **除非絕對需要，否則請勿使用延長電線。**使用不適當的延長電線會引起火災、觸電或觸電致死。
- **若要在戶外使用充電器，請使用適合乾燥場合和戶外使用的延長電線。**使用適合戶外使用的電線可減少觸電危險。

- **請勿堵住充電器上的通風槽。通風槽位於充電器的頂部和兩側。**請將充電器放到遠離熱源的位置。
- **切勿操作電線或插頭損壞的充電器** — 請立即更換損壞的部分。
- **如果充電器受到重擊、掉下來或出現其他損壞情況，請勿操作充電器，**並拿到授權維修中心修理。
- **切勿自行拆卸充電器。需要維護或修理時，請拿到授權維修中心。**重新組裝不當可能會導致觸電、觸電致死或火災。
- 若電源線損毀，必須讓製造廠商、檢修代理或類似合格人員更換以避免發生危險。
- **在清潔之前，請將充電器的插頭從電源插座上拔掉，這樣可以減低觸電風險。**拆除電池組並不能夠降低這種風險。
- **切勿**試圖將 2 個充電器連接在一起。
- **充電器是為標準 110 V 家用電源而設計。切勿**試圖使用其他電壓。本規定不適用於車載充電器。

### 請保存這些安全指示

## 充電器

DCB107 充電器可使用 10.8 伏特、14.4 伏特和 18 伏特鋰離子 (DCB121, DCB123, DCB125, DCB127, DCB140, DCB141, DCB142, DCB144, DCB145, DCB180, DCB181, DCB182, DCB183, DCB184 和 DCB185) 電池組。

本充電器毋須調節，設計容易使用。

## 充電程序 (圖 2)







1. 放進電池組前，先將充電器的插頭插到適當的 110 伏特插座。
2. 將電池組 (g) 放進充電器，確保電池組已完全放入。紅燈 (充電中) 會不斷閃爍，這表示充電程序已經開始。

3. 當紅燈會持續亮起時，代表充電完成。這個時候，電池組的電力全滿，可以立即使用或是留在充電器裡。

**註：**為了確保鋰離子電池的效能和使用壽命最大化，在第一次使用電池組之前必須將它完全充電。

## 充電程序

請見下表瞭解電池組的充電狀態。

充電狀態 – DCB107	
 充電中	— — — — — 
 電力全滿	————— 
 電池組熱/冷延遲	— — —   ——— 

### 電池組熱/冷延遲 (DCB107)

DCB107 充電器擁有熱/冷延遲功能。當充電器檢測到電池是熱的時，它將自動延遲充電，直到電池已經冷卻。

當充電器檢測到電池是冷的時，它將自動延遲充電，直到電池稍微變熱。

紅燈會繼續閃爍，但在執行此操作期間黃色指示燈將亮起。電池冷卻後，黃色指示燈將熄滅，充電器將恢復充電程序。

XR 鋰離子工具透過電子保護系統設計，保護電池免受過載、過熱或深度放電。

如果電子保護系統啟動，本工具會自動關閉。如果出現此情況，請將鋰離子電池放進充電器直到電力全滿。

## 所有電池組之重要安全指示

購買更換電池組時，務必附上目錄號和電壓資料。包裝內的電池組並未完全充電。在使用電池組和充電器之前，請先閱讀以下安全指示並遵循所列的充電程序。

### 請閱讀所有指示

- **不要在易爆環境，如有易燃液體、氣體或塵埃的環境中進行充電或使用電池組。**將電池組放進充電器或拆除電池組可能會點燃粉塵或氣體。
- **請勿強行將電池組放進充電器。請勿以任何方**

式改裝電池組以在不相容的充電器中使用，否則電池組可能會破裂，導致嚴重人身傷害。

- 請只使用原廠的 DEWALT 充電器為電池充電。
- 請勿將水份或其他液體飛濺到電池組或將電池組浸沒。
- 請勿在溫度可能達到或超過 40 °C (105 °F) 的地方（例如夏季時沒有遮擋的棚子或金屬建築物）儲存或使用本工具和電池。
- 為了達到最好的效果，請確保電池組在使用之前已完全充電。



**警告：**不論是因為任何理由，都不要嘗試打開電池。如果電池組的外殼破裂或損毀，請勿將電池組放進充電器。切勿撞擊、摔落或損毀電池組。請勿使用受到重擊、墜落或出現其他損壞情況的電池組或充電器（例如釘子刺穿、以錘子敲打或踐踏），否則可能會引起觸電或觸電致死。損毀的電池組應該送回維修中心進行回收。



**小心：**不使用工具時，請將工具放在穩定的表面上，以免導致絆倒或墜落等危險。一些具有大型電池組的工具可以直立但可能會輕易被撞倒。

### 鋰離子電池 (Li-Ion) 之特殊安全指示

- 即使電池組已嚴重損毀或磨損，請勿焚燒電池組。電池組可能會在火中爆炸。焚燒鋰離子電池組時會產生有毒氣體和物料。
- 如果電池液體接觸到皮膚，請立即以中性肥皂和清水沖洗接觸範圍。若電池液進入眼睛，立即用清潔的水沖洗 15 分鐘或直到刺激停止。如果需要接受治療，電池的電解質由液化有機碳酸鹽和鋰鹽構成。
- 開啟的電池中的物質可能會導致刺激呼吸道。請保持空氣流通。如果症狀持續，請尋求醫療協助。



**警告：**燒傷危險。電池液如遇到火花或火焰可能會引起燃燒。

## 電池組

### 電池類型

DCD734 需要使用 14.4 伏特電壓的電池組操作。

DCD771 和 DCD776 需要使用 18 伏特電壓的電池組操作。

DCB140, DCB142, DCB143, DCB144, DCB145, DCB180, DCB181, DCB182, DCB183, DCB184 或 DCB185 的電池組也可以使用。請參閱**技術資料**瞭解更多資訊。

### 儲存建議

1. 乾燥、涼爽、太陽不會直接照射、不會過熱或過冷的地方，就是電池組的最佳存放地點。為達到最大效能和使用壽命，不使用電池時請以室溫儲存電池組。
2. 欲長期儲存，建議將電力全滿的電池組從充電器卸下，儲存於涼爽、乾燥處，使電池組效能達到最佳。

**註：**電池組不應在電力耗盡的情況下儲存。在使用之前，電池組必須再次充電。

## 充電器和電池組上的標籤

除了本手冊的圖示之外，充電器和電池組上的標籤包含以下圖示：



使用前請閱讀使用手冊。



充電中。



電力全滿。



電池組熱/冷延遲。



電池組或充電器故障。





電源線故障。



切勿插入導電體。



切勿為損毀的電池組充電。



僅可以使用 DeWALT 電池組。其他電池組可能會爆裂，導致人身傷害和損害。



切勿接觸水份。



立即更換損壞的電線。



只在溫度介於 4°C 至 40°C 之間充電。



棄置電池組時要顧及環保。



切勿焚化電池。



為鋰離子電池組充電。



請參閱**技術資料**瞭解充電時間。



僅供室內使用。

## 套裝內的物件

本套裝包括：

- 1 電鑽/起子機或 1 個電鑽/起子機/電錘鑽
- 1 充電器
- 1 鋰離子電池組 (C1 型號)
- 2 鋰離子電池組 (C2 型號)
- 3 鋰離子電池組 (C3 型號)
- 1 工具箱
- 1 使用手冊

**註：**N 型號不隨附電池組、充電器和工具箱。

- 檢查工具、部件或配件有否在運送途中損壞。

- 操作前，請抽空徹底地閱讀和掌握本手冊的內容。

## 說明 (圖 1)



**警告：**切勿改動本電動工具或其任何部件，否則可能導致損壞或人身傷害。

- a. 觸發開關
- b. 正/反轉控制按鈕
- c. 扭矩調整環
- d. 換檔器
- e. 工作燈
- f. 無鎖匙夾頭
- g. 電池組
- h. 電池釋放按鈕
- i. 主手柄

## 設計用途

這些電鑽/起子機/電錘鑽是為專業鑽孔、衝擊鑽孔和螺絲安裝而設計。

**切勿**在潮濕有水或存有易燃液體或氣體的環境下使用工具。

這些電鑽/起子機/電錘鑽是專業電動工具。

**不要**讓兒童接觸本工具。缺乏經驗的操作人員需要在監督下使用本工具。

- 體力、感覺或智力不足，以及缺乏經驗、知識或技能的人員 (包括兒童) 不適合使用本產品，除非一旁有能為他們的安全負責的監督人員。切勿讓兒童單獨接觸本工具。

## 電力安全

電動機只適用一種電壓。請務必檢查電池組電壓是否與銘牌一致，並且確保充電器的電壓與電源電壓一致。



DeWALT 充電器根據 IEC 60335 進行雙重絕緣，因此不需要使用接地線。

若電源線損壞，必須使用 DeWALT 維修機構提供的專用電線進行更換。

## 使用延長電纜

如非絕對必要，否則不要使用延長電線。請使用與充電器的輸入功率相配的認可延長電纜（請參閱**技術資料**）。導體的最小尺寸為 1 mm<sup>2</sup>；最長為 30 m。

使用電纜捲筒時，每次必須把電纜完全展開。

## 裝配與調整



**警告：**為了減低造成嚴重人身傷害的風險，在進行任何調整或卸下或安裝附件或配件之前，切記關掉工具的電源並取出電池組。意外啟動工具可能會造成傷害。



**警告：**只可以使用 DeWALT 電池組和充電器。

## 放進及取出工具的電池組（圖 2）



**警告：**每次進行組裝和調整之前，務必取出電池組。放進或取出電池組之前，務必關閉工具。

**註：**為了達到最好的效果，請確保電池組已完全充電。

### 將電池組安裝到工具手柄中

1. 將電池組 (g) 和工具手柄裡的軌道對齊（圖 2）。
2. 將電池組滑入手柄，直到電池組緊緊固定並確保沒有鬆開。

### 卸下工具內的電池

1. 按下電池釋放按鈕 (h)，將電池組從工具手柄中穩妥地拉出。
2. 按照本手冊有關充電器的章節所述，將電池組放進充電器。

### 電量計電池組（圖 2）

一些 DeWALT 電池組帶有包含三個綠色 LED 燈的電量計，可以指示電池組的剩餘電量。

若要啟用電量計，請按下並按住電量計按鈕 (k)。三個綠色 LED 燈將以組合方式亮起，以指示剩餘電量。電池電量低於可用限值時，電量計不會亮起，此時需要對電池充電。

**註：**電量計只指示電池組的剩餘電量。它並不指示工具功能，且根據工具組件、溫度和最終使用者的應用而有所不同。

## 變速觸發開關（圖 1）

若要啟動工具，請擠壓觸發開關 (a)。若要把工具關掉，請鬆開觸發開關。本工具配有制動器。一旦完全鬆開觸發開關，夾頭就會馬上停止。

**註：**不建議在變速範圍內進行持續使用。這會損壞開關，應當避免。

## 正/反轉控制按鈕（圖 1）

正/反轉控制按鈕 (b) 決定工具的方向，同時具備鎖止按鈕功能。

若要選擇正轉，請鬆開觸發開關，然後按下工具右邊的正/反轉控制按鈕。

若要選擇反轉，請按下工具左邊的正/反轉控制按鈕。

當控制按鈕處於中心位置時，工具會被鎖定在關閉位置。要改變控制按鈕的位置時，請確定觸發器已經鬆開。

**註：**當您改變轉動方向後第一次操作工具，您可能會在啟動時聽到卡嗒聲。這是正常現象，不代表工具故障。

## 扭矩調整環（圖 1）

您的工具有一個可調節的扭矩螺絲起子機構，用來安裝和取出各種形狀和大小的扣件，而且在某些型號中還有一個錘擊機構，用來磚石鑽孔。調整環 (c) 的周圍是編號和鑽頭符號，在某些型號中，還有錘鑽符號。這些編號用於設定離合器以提供扭矩範圍。調整環上的編號越大，扭矩越高，且可安裝的扣件也越大。若要選擇任一編號，請旋轉調整環直到所需的編號與箭頭對齊。

## 雙速排擋 (圖 1)

藉助電鑽/起子機/電錘鑽的雙速功能，您可進行換檔以獲得更大的適用性。

1. 若要選擇速度 1 (高扭矩設定)，請關閉工具並讓它停止轉動。將換檔器 (d) 向前滑動 (滑向夾頭)。
2. 若要選擇速度 2 (低扭矩設定)，請關閉工具並讓它停止轉動。將換檔器向後滑動 (遠離夾頭)。

**註：**工具運轉時不要換檔。換檔之前，務必等待電鑽完全停止。如果無法換擋，請確保雙速換檔器已完全向前推動或完全向後推動。

## 工作燈 (圖 1)

工作燈 (e) 位於觸發開關 (a) 的上面。擠壓觸發開關時，工作燈就會亮起。鬆開觸發器後，工作燈最長將延遲 20 秒。

**註：**工作燈用於照亮緊鄰的工作表面，而不是設計作為手電筒。

## 無鎖匙單套夾頭 (圖 7-9)



**警告：**不要試圖以握住夾頭的前面部分並啟動工具來扭緊鑽頭 (或其他任何配件)。這可能會導致夾頭損壞和人身傷害。更換配件時，務必鎖定觸發開關並斷開工具電源。



**警告：**啟動工具之前應確保鑽頭安裝穩固。鬆動的鑽頭可能會從工具脫落，從而可能導致人身傷害。

您的工具配無鎖匙夾頭 (f)，帶有一個旋轉套管，以方便單手操作夾頭。若要插入鑽頭或其他配件，請執行以下步驟。

1. 關閉工具並斷開工具電源。
2. 用一隻手抓住夾頭的黑色套管，用另一隻手固定工具。逆時針旋轉套管到可接受所需配件的程度。
3. 將配件插入夾頭約 19 公釐 (3/4") 處，然後用一隻手順時針旋轉夾頭，另一隻手則握住工

具，將配件擰緊。您的工具配有一個自動主軸鎖機構。藉助此機構，您只需一隻手即可開啟和關閉夾頭。

擰緊夾頭時，務必用一隻手握住夾頭套管，用另一隻手握住工具，以獲得最大的緊密性。

若要鬆開配件，請重複上述步驟 1 和 2。

## 操作

### 使用說明



**警告：**務必遵守安全指示和適用的規則。



**警告：**為了減低造成嚴重人身傷害的風險，在進行任何調整或卸下或安裝附件或配件之前，切記關掉工具的電源並取出電池組。意外啟動工具可能會造成傷害。

## 正確的雙手放置位置 (圖 3)



**警告：**為降低遭受嚴重人身傷害的風險，務必如圖示那樣正確放置雙手。



**警告：**為降低遭受嚴重人身傷害的風險，預期有突然反應時務必握緊。

正確的雙手放置位置是一隻手放在電鑽頂端 (如圖所示)，另一隻手握住主手柄 (i)。

## 螺絲起子操作 (圖 4)

1. 使用雙速排擋選擇器選擇所需的速度/扭矩範圍以與操作計畫的速度和扭矩相符。
2. 將扭矩調整環 (c) 轉至所需位置。編號越小，表示扭矩設定越小；編號越大，表示扭矩設定越大。
3. 將所需的扣件配件插入任意鑽頭的夾頭。
4. 在較小或隱蔽區域進行一些實際運轉以確定夾頭調整環的正確位置。
5. 務必先從較低的扭矩設定開始，然後再使用較高的扭矩設定以避免損壞工件或扣件。

## 電鑽操作 (圖5)



**警告：**為了減低造成嚴重人身傷害的風險，在進行任何調整或卸下或安裝附件或配件之前，切記關閉工具並斷開工具電源。



**警告：**為了減低造成嚴重人身傷害的風險，務必確保工件已穩固地固定或夾住。若要在薄的材料上鑽孔，請使用木塊墊住以預防材料損壞。

1. 將調整環 (c) 轉至電鑽符號。
2. 使用換檔器選擇所需的速度/扭矩範圍以與操作計畫的速度和扭矩相符。
3. 對於木材，應使用麻花鑽頭、扁鑽頭、機械螺旋鑽頭或孔鋸。對於金屬，應使用高速鋼麻花鑽頭或孔鋸。在金屬上鑽孔時使用切割潤滑劑。鑄鐵和黃銅是例外，它們應保持乾燥而直接鑽孔。
4. 始終以與鑽頭方向成一直線的方式施加壓力。使用足夠的壓力讓鑽頭持續穿透，但不要太用力以致讓電動機失速或鑽頭偏斜。
5. 使用雙手緊握電鑽以控制電鑽的旋轉動作。如果該型號不帶側手柄，則用一隻手抓住電鑽手柄，另一隻手則抓住電池組。



**小心：**如果過載，電鑽可能會失速，導致突然旋轉。請保持警覺，並隨時有失速的心理準備。緊握電鑽以控制旋轉動作，避免傷害。

6. **電鑽失速**，通常是由於過載或使用不當導致。**請立即鬆開觸發器**，從工件上退出鑽頭，查找失速的原因。**不要按下又鬆開觸發器以試圖啟動失速的電鑽 — 這會損壞電鑽。**
7. 為儘量減少失速故障或避免鑽頭在材料中折斷，請降低對電鑽的壓力，使鑽頭從孔的最後部分中緩和下來。
8. 將鑽頭從已鑽好的洞拔出時，讓電機保持運轉。這有助於防止卡死。

9. 使用變速電鑽時，無需中心沖定位。啟動時採用較低速度，當鑽深足以防止跳鑽時，加力擠壓觸發器，使電鑽加速。

## 鏈鑽操作 (圖6)

### DCD776

1. 將調整環 (c) 轉至電鏈鑽符號。
  2. 向後滑動選擇器 (遠離夾頭)，選擇高速設定。
- 重要資訊：**只使用硬合金鑽頭或磚石鑽頭。
3. 鑽孔時，只需對錘子施加足夠的力，以防止過度反彈或「脫離」鑽頭。過多壓力將導致鑽孔速度變慢，過熱，鑽孔速度降低。
  4. 直線鑽孔，保持鑽頭與工件成直角。鑽孔時不要在鑽頭上施加側壓力，這將導致鑽頭凹槽阻塞，鑽孔速度變慢。
  5. 鑽深孔時，如果錘子速度開始減慢，在工具仍運轉的情況下，從孔中拔出部分鑽頭以幫助清理鑽屑。

**註：**如果鑽屑平滑、均勻地流出，則表明鑽孔速度適當。

## 維護

DEWALT 電動工具採用卓越的設計，能夠長時間使用，並且只需最少的維護。若要持續獲得滿意的操作效果，需進行正確的工具維護和定期的清潔。



**警告：**為了減低造成嚴重人身傷害的風險，在進行任何調整或卸下或安裝附件或配件之前，切記關掉工具的電源並取出電池組。意外啟動工具可能會造成傷害。

充電器和電池組是不可檢修的裝置。充電器和電池組內不含可檢修的部件。



## 潤滑

本電動工具毋需額外潤滑。



## 清潔



**警告：**一旦通風口及其周圍積聚了可見的塵埃，請立即使用乾燥的壓縮空氣吹掉主機外殼內的塵埃和灰塵。執行此步驟時，請佩戴經認可的護目裝備和防塵面罩。



**警告：**切勿使用溶劑或其他刺激性化學品來清潔工具的非金屬部件。這些化學品可能會削弱零件中使用的材料。只能使用抹布蘸中性肥皂水進行清潔。不要讓任何液體進入工具；不要讓工具的任何部分浸入液體中。

### 充電器清潔指示



**警告：**觸電危險。在清潔之前，請將充電器的插頭從電源插座上拔掉。使用軟布或非金屬軟刷，去除充電器外部的污垢和油脂。請勿使用水或任何清潔劑。

### 選購配件



**警告：**由於非 DeWALT 所提供的配件未在本產品上進行過使用測試，在本產品上使用這些配件可能會導致危險。為降低傷害危險，在本產品上只應使用 DeWALT 所推薦的配件。

如需進一步瞭解適用配件的相關資訊，請洽詢當地代理商。

### 保護環境



個別收集。本產品必須與一般家庭廢物分開處置。

若您發現您的 DeWALT 產品需要進行替換，或您已經不再需要使用這些產品，請不要將它們與家庭廢物一起處置。務必將本產品送往分類收集處。



個別收集用過的產品和包裝允許材料再循環利用。重新使用循環利用的材料有助於防止環境污染，並減少原始材料的需求。

當地法規可能要求由市政廢物回收點，或由向您出售新產品的經銷商來提供從家庭中分類收集電子產品的服務。

DeWALT 提供設施收集和回收使用壽命結束的 DeWALT 產品。若要享受此項服務，請將產品送回任一授權維修中心，由其代表我們進行收集。

請根據本手冊上所提供地址與當地 DeWALT 辦事處聯絡，查詢離您最近的授權維修中心所在位置。您亦可瀏覽網站查詢 DeWALT 授權維修中心清單和售後服務及聯絡資料之詳細資訊，網址是：[www.2helpU.com](http://www.2helpU.com)。



### 可充電電池組

本電池組使用壽命長，如無法完成理應輕鬆完成的工作時，必須為電池組充電。在使用壽命結束時，請妥善處置以保護我們的環境：

- 使電池完全放電，然後將它從工具中卸下。
- 鋰離子電池是可回收的。請將它們送往您的代理商或當地的回收站。所收集的電池組將會再循環利用或妥善處置。

**進口商：永安實業股份有限公司**

**地址：新北市三重區新北大道二段137號**

**電話：02-29994633**

# 충전식 컴팩트 13 mm (1/2") 드릴/드라이버/ 해머 드릴 DCD734, DCD771, DCD776

## 축하합니다!

DeWALT 공구를 선택해 주셔서 감사합니다. DeWALT는 오랜 경험과 제품 개발 및 혁신을 통해 전문 전동 공구 사용자들이 인정하는 기업으로 자리잡아 왔습니다.

## 기술 데이터

		DCD734	DCD771	DCD776
전압	$V_{DC}$	14.4	18	18
유형		1	1	1
배터리 유형		리튬 이온	리튬 이온	리튬 이온
전원 출력	W	250	300	300
무부하 속도				
1차 기어	분 <sup>-1</sup>	0-400	0-450	0-450
2차 기어	분 <sup>-1</sup>	0-1300	0-1500	0-1500
분당타격수				
1차 기어	분 <sup>-1</sup>	-	-	0-7650
2차 기어	분 <sup>-1</sup>	-	-	0-25 500
최대 토크(하드/소프트)	Nm	38/22	42/24	42/24
척 크기	mm	13	13	13
최대 드릴 작업 용량				
목재	mm	30	30	30
철재	mm	10	13	13
석재	mm	-	-	13
무게 (배터리 팩 제외)	kg	1.2	1.3	1.34

배터리 팩		DCB140	DCB141	DCB142	DCB143	DCB145
배터리 유형		리튬 이온	리튬 이온	리튬 이온	리튬 이온	리튬 이온
전압	$V_{DC}$	14.4	14.4	14.4	14.4	14.4
용량	$A_h$	3.0	1.5	4.0	2.0	1.3
무게	kg	0.53	0.30	0.54	0.30	0.30

배터리 팩		DCB185	DCB181	DCB183	DCB180	DCB182
배터리 유형		리튬 이온	리튬 이온	리튬 이온	리튬 이온	리튬 이온
전압	$V_{DC}$	18	18	18	18	18
용량	$A_h$	1.3	1.5	2.0	3.0	4.0
무게	kg	0.35	0.35	0.40	0.64	0.61

충전기		DCB107				
전원 전압	$V_{AC}$	220V				
배터리 유형		리튬 이온				
대략적 충전 시간	분	60 (1.3 Ah 배터리 팩)	70 (1.5 Ah 배터리 팩)	90 (2.0 Ah 배터리 팩)	140 (3.0 Ah 배터리 팩)	180 (4.0 Ah 배터리 팩)
무게	kg	0.49				

## 정의: 안전 지침

다음 정의는 각 경고 문구의 심각도를 설명합니다. 사용 설명서를 읽고 다음 기호들에 유의하십시오.



**위험:** 절박한 위험 상태를 나타내며, 방지하지 않으면 **사망 또는 심각한 부상을 초래합니다.**



**경고:** 잠재적 위험 상태를 나타내며, 방지하지 않으면 **사망 또는 심각한 부상을 초래할 수 있습니다.**



**주의:** 잠재적 위험 상태를 나타내며, 방지하지 않으면 **경미한 부상을 초래할 수 있습니다.**

**참고:** 신체 부상을 초래하지 않는 행위를 나타내며, 방지하지 않으면 재산상의 손해가 발생할 수 있습니다.



감전 위험을 나타냅니다.



화재 위험을 나타냅니다.



**경고:** 부상 위험을 줄이려면 사용 설명서를 숙지하십시오.

## 전동 공구에 관한 일반 안전 경고



**경고! 안전 경고와 지시사항을 모두 읽으십시오.** 경고와 지시 사항을 준수하지 않으면 감전, 화재 및/또는 심각한 부상을 초래할 수 있습니다.

**향후 참고할 수 있도록 모든 경고 및 지시 사항을 보관해두십시오.**

경고에서 사용된 "전동 공구"라는 용어는 주 공급 전원에 의해 전기가 공급되는(유선) 전동 공구 또는 충전식(무선) 전동 공구를 의미합니다.

### 1) 작업장 안전

- 작업 영역을 청결히 하고 조명을 밝게 유지하십시오. 혼잡하거나 어두운 작업장에서는 사고가 발생하기 쉽습니다.
- 자연성 액체, 가스 또는 먼지 등이 있는 폭발성 대기에서 전동 공구를 사용하지 마십시오. 전동 공구에서 먼지나 가스를 발화시킬 수 있는 불꽃이 될 수 있습니다.
- 전동 공구로 작업하는 동안에는 어린이와 주변 사람들이 작업 영역에 가까이 들어오지 못하도록 하십시오. 주변이 산만해져 통제력을 잃을 수 있습니다.

### 2) 전기 안전

- 전동 공구의 플러그는 콘센트와 형식이 일치해야 합니다. 플러그를 어떤 방식으로든 절대 개조하지 마십시오. 접지된(지면 접지) 전동 공구에 어떤 어댑터 플러그도 사용하지 마십시오. 개조되지

않은 플러그 및 형식이 일치하는 콘센트를 사용하면 감전 위험이 줄어듭니다.

- 파이프, 라디에이터, 렌치 및 냉각고 등과 같이 접지된 표면에 신체가 접촉하지 않도록 하십시오. 신체가 접지되어 있으면 감전 위험이 높아집니다.
- 전동 공구를 비 또는 습한 환경에 노출하지 않도록 주의하십시오. 전동 공구에 물이 들어가면 감전 위험이 높아집니다.
- 코드를 합부로 다루지 마십시오. 코드를 사용하여 전동 공구를 운반하거나 잡아당기거나 플러그를 뽑지 마십시오. 열, 오일, 날카로운 모서리 또는 움직이는 부품에서 멀리 떨어진 장소에 코드를 보관하십시오. 코드가 손상되거나 얽혀 있으면 감전 위험이 높아집니다.
- 전동 공구를 실외에서 사용할 때는 실외 사용에 적합한 연장 코드를 사용하십시오. 실외 사용에 적합한 코드를 사용하면 감전 위험이 줄어듭니다.
- 어쩔 수 없이 습한 장소에서 전동 공구를 사용해야 하는 경우에는 누전 차단기(RCD)로 보호된 전원 공급 장치를 사용하십시오. RCD(차단기)를 사용하면 감전 위험이 줄어듭니다.

### 3) 신체 안전

- 전동 공구로 작업할 때는 방심하지 말고 작업에 주의하면서 상식을 따르십시오. 피곤한 상태이거나 약물, 술, 치료제를 복용한 상태에서는 전동 공구를 사용하지 마십시오. 전동 공구를 사용하는 중에 주의력을 잃어 순간적으로 부상을 당할 수 있습니다.
- 신체 보호 장비를 착용하십시오. 항상 보안경을 착용하십시오. 적합한 상황에서 방진 마스크, 미끄럼 방지 안전화, 안전모 또는 청력 보호 기구 등의 보호 장비를 사용하면 신체 부상 위험이 줄어듭니다.
- 의도하지 않은 장비 가동 방지. 전원 및/또는 배터리 팩에 연결한 상태를 공구로 선택 또는 운반할 때는 사전에 스위치가 꺼짐 위치에 있는지 반드시 확인하십시오. 스위치가 켜짐 위치에 있는 상태에서 전동 공구를 운반하거나 전동 공구에 전원을 공급하면 사고가 발생합니다.
- 전동 공구를 켜기 전에 모든 조정 키 또는 렌치를 제거하십시오. 전동 공구의 회전 부품에 렌치나 키가 부착되어 있으면 부상을 당할 수 있습니다.
- 무리하게 팔을 뻗지 마십시오. 항상 올바른 자세로 서서 균형을 유지하십시오. 그러면 예기치 않은 상황에서 전동 공구에 대한 제어력이 상실됩니다.
- 적절한 작업복을 착용합니다. 헐렁한 옷이나 장신구를 착용하지 마십시오.

머리카락, 옷 및 장갑이 움직이는 부품에 닿지 않도록 유의하십시오. 훌륭한 옷, 장신구 또는 긴 머리카락이 움직이는 부품에 걸 수 있습니다.

- g) 먼저 배출 및 집진 시설 연결을 위한 장치가 제공된 경우, 이들 장치가 연결되어 적절히 사용되고 있는지 반드시 확인하십시오. 집진 장치를 사용하면 먼지와 관련된 위험을 줄일 수 있습니다.

**4) 전동 공구 사용 및 관리**

- a) 전동 공구에 무리한 힘을 가하지 마십시오. 해당 용도에 맞는 올바른 전동 공구를 사용하십시오. 올바른 전동 공구를 사용해야 설계된 속도로 작업을 더욱 안전하고 정확하게 수행할 수 있습니다.
- b) 켜지거나 꺼지지 않는 경우 전동 공구를 사용하지 마십시오. 스위치로 제어되지 않는 전동 공구는 위험하며 수리해야 합니다.
- c) 전동 공구를 조정하거나 액세서리를 변경하거나 보관하기 전에 전원 및/또는 배터리 팩에서 플러그를 뽑으십시오. 이러한 예방적 안전 조치를 따라야 전동 공구가 갑자기 작동할 위험이 줄어듭니다.
- d) 사용하지 않는 전동 공구는 어린이의 손이 닿지 않는 곳에 보관하고, 전동 공구나 본 장치 사항에 익숙하지 않은 사람이 전동 공구를 절대 사용하지 못하게 하십시오. 전동 공구는 훈련을 받지 않은 사용자가 다루면 위험합니다.
- e) 전동 공구 유지 보수, 움직이는 부품의 잘못된 정렬이나 바인딩, 부품 파손 및 기타 전동 공구의 작동에 영향을 미칠 수 있는 기타 모든 상태를 확인하십시오. 손상된 부분이 있는 경우 사용하기 전에 전동 공구를 수리하십시오. 많은 사고는 전동 공구를 제대로 유지 보수하지 않아 발생합니다.
- f) 절단 공구를 예리하고 깨끗한 상태로 유지하십시오. 절단지석 가장자리를 예리하게 잘 유지하면 절단기를 사용할 때 바인딩이 적고 다루기가 용이합니다.
- g) 작업 환경과 수행할 작업을 고려하여, 본 장치 사항에 따라 전동 공구, 액세서리 및 틀 비트 등을 사용하십시오. 본 사용 설명서의 내용과 다른 용도로 전동 공구를 사용하면 위험한 상황이 발생할 수 있습니다.

**5) 배터리 공구 사용 및 관리**

- a) 다시 충전할 때는 제조업체에서 지정한 충전기에 적합한 충전기를 다른 배터리 팩과 함께 사용할 경우 화재의 위험이 있습니다.
- b) 전동 공구를 사용할 때는 특수 설계된 배터리 팩을 함께 사용하십시오. 다른 배터리 팩을 사용하면 부상을 입거나 화재의 위험이 있습니다.

- c) 배터리 팩을 사용하지 않을 때에는 클립, 동전, 키, 못, 나사 등의 금속 물체나, 단자 간에 연결할 수 있는 작은 금속 물체가 닿지 않도록 멀리 두십시오. 배터리 단자가 단락되면 화상을 입거나 화재의 위험이 있습니다.
- d) 배터리를 과다 사용하면 액체가 배터리에서 흘러 나올 수 있으므로 접촉을 피하십시오. 실수로 접촉한 경우에는 물로 씻으십시오. 액체가 눈에 들어가면 치료를 받으십시오. 배터리에서 나온 액체는 통증을 유발하거나 화상을 입힐 수 있습니다.

**6) 정비**

- a) 자격을 갖춘 기술자가 동일 교체 부품을 사용하여 정비 작업을 수행해야 합니다. 그레아 전동 공구의 안전이 보장됩니다.

**드릴/드라이버/해머 드릴에 특정하게 적용되는 추가 안전 규칙**

- 임팩트 드릴 작업 시에는 귀 보호 장구를 착용하십시오. 소음에 노출되면 청력이 손상될 수 있습니다.
- 보조 핸들(공구와 함께 제공된 경우)을 사용하십시오. 제어력을 잃으면 신체 부상을 당할 수 있습니다.
- 절삭 액세서리가 숨겨진 배선에 접촉할 수 있는 작업을 수행할 때는 절연된 그림핑 표면이 닿도록 하여 전동 공구를 잡으십시오. "전류가 흐르는" 전선에 접촉된 절삭 액세서리는 전동 공구의 노출된 금속 부품을 "전류가 흐르는" 상태로 만들어 작업자를 감전시킬 수 있습니다.
- 클램프 또는 다른 적절한 방식을 이용하여 안정된 작업대에 작업 공구들을 고정 및 지지하십시오. 작업물을 손으로 잡거나 몸에 지지하는 행동은 불안정하며, 제어력을 잃을 수 있습니다.
- 안전 고글 또는 기타 눈 보호 장구를 착용하십시오. 해머 및 드릴 작업 시 파편이 날아갈 수 있습니다. 파편이 날아가 눈이 영구적으로 손상될 수 있습니다.
- 작업 중에는 액세서리와 공구가 뜨거울 수 있습니다. 금속 해머 드릴 및 드릴 등 발열 작업을 수행하는 경우에는 취급 시 장갑을 착용하십시오.
- 본 공구를 장시간 사용하지 마십시오. 해머 작동으로 인한 진동은 손과 팔에 유해할 수 있습니다. 장갑을 사용하여 추가 쿠션을 제공하고 종종 휴식을 취하여 진동에 의한 노출을 제한하십시오.



- 공기 구멍이 종종 움직이는 부품에 의해 닫히므로 방지해야 합니다. 헐렁한 옷, 장신구 또는 긴 머리카락이 움직이는 부품에 걸 수 있습니다.

## 기타 발생 가능한 위험

드릴 사용 시에는 다음과 같은 위험이 수반됩니다.

- 공구의 회전부를 만지거나 가열된 부위에 닿아 발생한 부상.

관련된 안전 규정을 준수하고 안전 장치를 사용한다고 해도 특정한 위험은 피할 수 없습니다. 이러한 위험은 다음과 같습니다.

- 청력 손상.
- 액세서리를 교체할 때 손가락이 끼일 위험
- 나무 가공 시 발생한 먼지를 들이마셔서 발생할 수 있는 건강 위험.
- 파편 날림으로 인한 신체 부상 위험.
- 장시간 사용으로 인한 신체 부상의 위험.

## 공구에 표시된 마크

공구에는 다음과 같은 그림이 있습니다.



사용 전에 사용 설명서의 내용을 숙지하십시오.

### 날짜 코드 위치(그림 1)

날짜 코드(①)에는 제조년도가 포함되어 이 제조년도는 공구와 배터리의 탑재 이음부가 되는 케이스에 인쇄되어 있습니다.

예:

2014 XX XX

제조년도

## 모든 배터리 충전기에 대한 중요한 안전 지침

**본 지침을 잘 보관해 두십시오.** 본 사용 설명서에는 DOB107 배터리 충전기에 대한 중요한 안전 및 작업 지침이 포함되어 있습니다.

- 충전기를 사용하기 전에 충전기, 배터리 팩, 그리고 배터리 팩 관련 제품에 대한 지침과 주의 표시를 숙지하십시오.



**경고:** 감전 위험. 충전기 내부에 액체가 들어가지 않도록 하십시오. 감전될 수 있습니다.



**주의:** 화상 위험. 신체 부상의 위험을 줄이려면 DeWALT 충전용 배터리 팩으로만 충전하십시오. 다른 배터리 팩 종류는 과열되어 터질 수 있으며, 부상과 재산 상의 손해를 입을 수 있습니다.



**주의:** 어린이가 본 제품을 가지고 놀지 못하도록 항상 주의해야 합니다.

**참고:** 특정 조건에서, 충전기가 전원 공급기에 연결되어 있으면 충전기 내부에 노출된 충전 접점이 이물질에 의해 단락될 수 있습니다. 스틸 울(steel wool), 알루미늄 호일, 금속 입자 축적물 등의 전도성 이물질은 충전기 캐비티에 닿지 않게 해야 합니다. 캐비티 안에 배터리 팩이 없을 경우 항상 배터리 전원 공급기에서 충전기의 플러그를 뽑으십시오. 충전기를 청소할 때는 플러그를 뽑아야 합니다.

- 본 사용 설명서에 명시된 충전기 외의 다른 충전기로 배터리 팩을 충전하지 마십시오. 본 충전기와 배터리 팩은 함께 사용하도록 특수 설계되었습니다.
- 이러한 충전기는 DeWALT 충전용 배터리 충전 이외의 용도로는 사용할 수 없습니다. 다른 용도로 사용하면 화재, 감전 또는 감전사의 위험이 있습니다.
- 충전기가 비나 눈을 맞지 않도록 하십시오.
- 충전기를 분리할 때는 코드가 아니라 플러그를 뽑으십시오. 그래야만 전기 플러그 및 코드 손상의 위험이 줄어듭니다.
- 코드가 밟히거나 걸리거나 기타 원인에 의해 손상되거나 압박을 받지 않도록 유의하십시오.
- 불가피한 경우가 아니면 연장 코드를 사용하지 마십시오. 연장 코드를 잘못 사용하면 화재, 감전 또는 감전사의 위험이 있습니다.
- 충전기를 실외에서 사용할 때는 건조한 장소에서 실외 사용에 적합한 연장 코드를 사용하십시오. 실외 사용에 적합한 코드를 사용하면 감전 위험이 줄어듭니다.
- 충전기의 환기구를 막지 마십시오. 환기 구멍은 충전기 상단 및 측면에 있습니다. 충전기는 열원에 가까이 두지 마십시오.
- 코드나 플러그가 손상된 충전기를 작동시키지 마십시오. 즉시 교체하십시오.
- 심한 충격을 받았거나 떨어뜨렸거나 기타의 방식으로 손상된 경우에는 충전기를 작동시키지 마십시오. 공인 서비스 센터로 가져가십시오.
- 충전기를 분해하지 마십시오. 서비스나 수리가 필요한 경우에는 공인 서비스 센터로 가져가십시오. 잘못 재조립하면 화재, 감전 또는 감전사의 위험이 있습니다.
- 전원 코드가 손상된 경우 위험을 방지하려면 제조업체, 서비스 대리점 또는 이에 준하는 자격을 가진 수리 기술자가 즉시 전원 코드를 교체해야 합니다.

- **최소하려면 먼저 충전기를 콘센트에서 분리하십시오. 그래야 감전 위험이 줄어듭니다.** 배터리 팩을 제거하는 것만으로 이러한 위험이 줄어들지는 않습니다.
- **절대로 충전기 두 개를 함께 연결하지 마십시오.**
- **충전기는 가정용 표준 전력(220 V)에서 작동하도록 설계되어 있습니다. 다른 전압에서는 사용하지 마십시오.** 차량용 충전기는 제외됩니다.

본 지침을 잘 보관해 두십시오.

## 충전기

DCB107 충전기에는 10.8 V, 14.4 V 및 18 V 리튬 이온(DCB121, DCB123, DCB125, DCB127, DCB140, DCB141, DCB142, DCB144, DCB145, DCB180, DCB181, DCB182, DCB183, DCB184 and DCB185) 배터리 팩을 사용할 수 있습니다.

이러한 충전기는 어떠한 조정 작업이 필요하지 않으며 최대한 작동하기 쉽게 설계되었습니다.

## 충전 절차(그림 2)

1. 배터리 팩을 넣기 전에 충전기를 적절한 220V 콘센트에 꽂습니다.
2. 배터리 팩(Ⓞ)을 충전기에 끼우고, 팩이 충전기에 완전히 들어갔는지 확인하십시오. 빨간색(충전 중) 불이 계속 깜박이면서 충전 프로세스가 시작되었음을 알립니다.
3. 충전이 완료되면 빨간색 불이 계속 켜져 있습니다. 팩이 완전히 충전되면 바로 사용하거나 충전기에 그대로 둡니다.

**참고:** 리튬이온 배터리의 성능과 수명을 극대화하려면 처음 사용하기 전에 배터리 팩을 완전히 충전시키십시오.

## 충전 프로세스

배터리 팩의 충전 상태는 아래 표를 참조하십시오.

충전 상태-DCB107	
	충전 중
	완전 충전됨
	냉/온 팩 지연

### 냉/온 팩 지연(DCB107)

DCB107 충전기에는 냉/온 이연 기능이 있습니다. 충전기에서 너무 뜨거운 배터리가 감지되면, 자동으로 배터리가 식을 때까지 충전을 지연시킵니다.

충전기에서 너무 차가운 배터리가 감지되면, 자동으로 배터리가 따뜻해질 때까지 충전을 지연시킵니다.

빨간색 표시등이 계속 깜박거리지만, 노란색 표시등은 이 작동 동안 계속 켜져 있습니다. 배터리가 차가워지면, 노란색 표시등이 꺼지고 충전기에서 충전 절차를 다시 시작합니다.

XR 리튬이온 배터리는 배터리에 과부하가 걸리거나 과열 또는 완전 방전되는 것을 방지하는 전자 보호 시스템으로 설계되었습니다.

이 공구는 전자 보호 시스템이 작동하면 자동으로 꺼집니다. 이러한 경우 리튬 이온 배터리가 완전히 충전될 때까지 충전기에 리튬 이온 배터리를 넣으십시오.

## 모든 배터리 팩에 대한 중요한 안전 지침

배터리 팩 교체를 하기 위해 주문할 때는 카탈로그 번호와 전압을 반드시 확인하고 표기해야 합니다.

배터리 팩은 카톤에서 꺼낼 때 완전히 충전된 상태가 아닙니다. 배터리 팩과 충전기를 사용하기 전에 아래 안전 지침을 숙독한 후 요약되어 있는 충전 절차를 따르십시오.

### 모든 지시 사항을 읽으십시오.

- **가연성 액체, 가스 또는 먼지 등으로 인한 폭발할 가능성이 있는 환경에서 배터리 팩을 충전하거나 사용하지 마십시오.** 배터리 팩을 끼우거나 충전기에서 분리할 때 먼지나 가스에 불이 붙을 수 있습니다.
- **충전기에 배터리 팩을 너무 세게 밀어 넣지 마십시오.** 어떤 형태로든 호환되지 않는 충전기에 사용하기 위해 배터리 팩을 개조하지 마십시오. 배터리 팩이 파열되어 심각한 부상을 유발할 수 있습니다.
- 지정된 DeWALT 충전기에서만 배터리 팩을 충전하십시오.
- 물이나 기타 액체가 튀어 묻거나 액체에 빠지지 않도록 하십시오.
- 온도가 40 °C (105 °F)를 초과할 수 있는 곳 (여름철 허름한 창고 또는 금속 건물 등)에 공구와 배터리 팩을 보관하거나 사용하지 마십시오.
- 최상의 결과를 위해 사용하기 전에 배터리 팩이 완전히 충전되었는지 확인하십시오.



**경고:** 어떤 이유로든 배터리 팩을 절대 분해하지 마십시오. 배터리 팩 케이스가 깨지거나 손상되면 충전기에 넣지 마십시오. 배터리 팩을 뭉개거나 떨어뜨리거나 손상시키지 마십시오. 강한 충격을 받았거나, 떨어뜨렸거나, 차에 치였거나 기타의 원인으로 어떤 방식으로든 손상된(예: 못이 박히거나 망치로 맞았거나 밟힘) 배터리 팩이나 충전기는 사용하지 마십시오. 감전 또는 감전사의 위험이 있습니다.

손상된 배터리 팩은 재활용을 위해 서비스 센터에 반환해야 합니다.



**주의: 사용하지 않는 공구는 걸려 넘어지거나 떨어질 위험이 없는 안정된 표면에 놓혀 두십시오.** 배터리 팩이 큰 일부 공구들은 배터리 팩 위에 바로 서 있지만 쉽게 넘어질 수 있습니다.

### 리튬 이온 (Li-Ion)에 대한 추가 안전 지침

- 배터리 팩이 심하게 손상되거나 완전히 낡았다더라도 절대 소각하지 마십시오. 배터리 팩은 불 속에서 폭발할 수 있습니다. 리튬이온 배터리 팩은 연소되면서 독성 연기와 물질을 발생시킵니다.
- 배터리 내용물이 피부에 닿으면 즉시 중성 세척제로 해당 부위를 씻으십시오. 배터리액이 눈에 들어갔을 경우, 15분 정도 또는 통증이 가실 때까지 눈을 뜨고 물로 씻어냅니다. 치료가 필요한 경우를 위해, 배터리 전해질은 액체 유기 탄산염과 리튬염의 혼합물로 구성되어 있음을 알아 두십시오.
- 열린 배터리 셀의 내용물은 호흡기 질환을 일으킬 수 있습니다. 신선한 공기를 마시십시오. 증상이 계속되면 치료를 받으십시오.



**경고: 화상 위험.** 배터리액은 불꽃이나 화염에 노출되면 연소될 수 있습니다.

## 배터리 팩

### 배터리 유형

DCD734 은 14.4 볼트 배터리 팩에서 작동합니다.

DCD771 및 DCD776 은 18 볼트 배터리 팩에서 작동합니다.

DCB140, DCB142, DCB143, DCB144, DCB145, DCB180, DCB181, DCB182, DCB183 또는 DCB185 배터리 팩을 사용할 수 있습니다. 자세한 정보는 **기술 데이터**를 참조하십시오.

## 보관 권장 사항

1. 보관 장소로는 직사광선을 받지 않고 지나치게 덥거나 춥지 않은 시원하고 건조한 곳이 가장 좋습니다. 최적의 배터리 성능과 수명을 위해, 사용하지 않을 때에는 배터리 팩을 실온에서 보관하십시오.
2. 장기간 보관하는 경우, 최적의 결과를 위해 완전히 충전된 배터리 팩을 충전기에서 분리하여 차갑고, 건조한 장소에 보관하는 것이 좋습니다.

**참고:** 배터리 팩은 완전히 방전된 상태로 보관해서는 안됩니다. 사용 전에 배터리 팩을 재충전해야 합니다.

## 충전기 및 배터리 팩에 부착된 레이블

본 설명서에 사용된 그림 외에도 충전기 및 배터리 팩에 부착된 레이블에는 다음과 같은 그림이 표시되어 있습니다.



사용 전에 사용 설명서의 내용을 숙지하십시오.



충전 중.



완전 충전됨.



냉/온 팩 지연.



문제 팩 또는 충전기.



문제 송전선.



전도성 있는 물체로 시험하지 마십시오.



손상된 배터리 팩을 충전하지 마십시오.



DeWALT 배터리 팩만 사용하십시오. 다른 것을 사용하면 배터리가 폭발하여 신체 부상을 당하거나 손해를 입을 수 있습니다.



물에 닿지 않도록 하십시오.



손상된 코드는 즉시 교체하십시오.



4°C ~ 40°C 사이에서만 충전하십시오.



환경 보호 차원에서 배터리 팩을 폐기하십시오.

LI-ION



배터리 팩을 소각하지 마십시오.



리튬이온 배터리 팩을 충전합니다.



충전 시간은 **기술 데이터**를 참조하십시오.



실내용만 해당.

## 포장 내용물

포장에는 다음 내용물이 들어 있습니다.

- 1 드릴/드라이버 1개 또는 드릴/드라이버/해머 드릴 1개
- 1 충전기
- 1 리튬이온 배터리 팩(C1 모델)
- 2 리튬이온 배터리 팩(C2 모델)
- 3 리튬이온 배터리 팩(C3 모델)
- 1 공구박스
- 1 사용 설명서

**참고:** 배터리 팩, 충전기 및 공구박스는 N 모델에 포함되지 않습니다.

- 운반 중에 발생할 수 있는 공구, 부품 또는 액세서리의 손상 여부를 확인하십시오.
- 작동 전에 시간을 내어 본 사용 설명서를 읽고 숙지하십시오.

## 설명 (그림 1)



**경고:** 전동 공구 또는 전동 공구의 어떤 부품도 절대 개조하지 마십시오. 제품이 파손되거나 신체 부상을 당할 수 있습니다.

- a. 트리거 스위치
- b. 전진/후진 제어 버튼
- c. 토크 조절 칼라
- d. 기어 변속장치
- e. 작업등
- f. 키가 필요없는 척
- g. 배터리 팩
- h. 배터리 탈착 버튼
- i. 주 핸들

## 용도

본 드릴/드라이버/해머 드릴은 나사를 조이거나 전문가용 드릴, 진동 드릴 작업용으로 설계되었습니다.

습한 환경이나 가연성 액체 또는 가스가 있는 장소에서 사용하지 **마십시오.**

본 드릴/드라이버/해머 드릴은 전문가용 공구입니다.

어린이가 이 공구를 만지지 않도록 하십시오. 경험이 없는 작업자가 이 공구를 사용할 때는 감독자의 지도가 필요합니다.

- 본 제품은 안전 책임을 맡고 있는 사람이 감독을 하고 있지 않는 한 경험, 지식 또는 기술이 부족하고 신체적, 감각적 또는 정신적 능력이 미약한 사람(어린이 포함)이 사용하도록 고안된 것이 아닙니다. 이 제품과 함께 어린이만 혼자 두어서는 안됩니다.

## 전기 안전

전기 모터는 한 가지 전압에만 맞추어 설계되었습니다. 배터리 팩 전압이 명판에 기재된 전압과 일치하는지 항상 확인하십시오. 또한 충전기의 전압이 주전원의 전압과도 일치하는지 확인하십시오.



DEWALT 충전기는 IEC 60335에 따라 이중 절연되어 있습니다. 따라서 접지선이 필요하지 않습니다.

전원 코드가 손상된 경우에는 DEWALT 서비스 센터를 통해 특수 제작된 코드로 교체해야만 합니다.

## 연장 케이블 이용

연장 코드는 가급적 사용하지 마십시오. 사용 중인 전원공급기 정격전원에 맞는 승인된 연장 코드를 사용하십시오(**기술 데이터** 참조). 최대 도체 크기는 1 mm<sup>2</sup>, 최대 길이는 30 m입니다.

케이블 릴을 사용할 때는 항상 케이블을 완전히 푸십시오.

## 조립 및 조정



**경고: 심각한 신체 부상의 위험을 줄이려면 공구를 조정하거나 부착물 또는 액세서리를 제거/설치하기 전에 공구를 끄고 배터리 팩을 분리하십시오.** 공구가 갑자기 작동하여 부상을 당할 수 있습니다.



**경고:** DEWALT 배터리 팩 및 충전기만 사용하십시오.

## 배터리 팩 삽입 및 공구에서 배터리 팩 분리(그림 2)



**경고:조립 및 조절 작업 전에는 항상 배터리 팩을 분리하십시오. 배터리 팩을 끼우거나 분리하기 전에 항상 공구 스위치를 끄십시오.**

**참고:** 최상의 결과를 위해 배터리 팩이 완전히 충전되었는지 확인하십시오.

## 배터리 팩을 공구 핸들에 설치하려면

1. 배터리 팩(①)을 공구의 안쪽 레일에 맞게 조정합니다(그림 2).
2. 공구에 배터리 팩이 견고하게 장착될 때까지 핸들에 밀어 넣고 분리되지 않는지 확인하십시오.

## 공구에서 배터리 팩을 분리하려면

1. 배터리 해제 버튼(h)을 누르고 배터리 팩을 공구 핸들에서 완전히 빼냅니다.
2. 본 사용 설명서의 충전기 섹션에 설명된 대로 배터리 팩을 충전기에 삽입합니다.

## 연료계 배터리 팩(그림 2)

일부 DEWALT 배터리 팩에는 배터리 팩의 남아 있는 충전 레벨을 표시하는 세 개의 녹색 LED 등으로 구성된 연료계가 포함되어 있습니다.

연료계를 작동시키려면, 연료계 버튼(k)을 누릅니다. 녹색 LED 표시등 3개가 조합되어 커짐으로써 충전 잔량 수준을 나타냅니다. 배터리 잔량이 사용 가능한 한계치 미만이면 배터리 잔량표시계가 켜지지 않으며 배터리를 재충전해야 합니다.

**참고:** 배터리 잔량표시계는 배터리 팩에 남아 있는 충전 레벨을 나타내는 것일 뿐입니다. 공구의 기능성을 나타내는 것이 아니며 제품 구성품, 온도 및 최종 사용자의 용도에 따라 변경될 수 있습니다.

## 가변 속도 트리거 스위치(그림 1)

공구를 켜려면 트리거 스위치(a)를 꼭 쥐십시오. 공구를 끄려면 트리거 스위치를 놓습니다. 공구에는 브레이크가 장착되어 있습니다. 트리거 스위치가 완전히 해제되는 즉시 적은 중지됩니다.

**참고:** 가변 속도 범위의 지속적 사용은 권장되지 않습니다. 지속적 사용은 스위치를 손상시킬 수 있으므로 피해야 합니다.

## 전진/후진 제어 버튼 (그림 1)

전진/후진 제어 버튼 (b)은 공구 방향을 결정하며 잠금 해제 버튼 역할도 합니다.

전진 회전을 선택하려면 트리거 스위치를 놓고 공구 오른쪽에 있는 전진/후진 제어 버튼을 눌러줍니다.

후진을 선택하려면 공구 왼쪽에서 전진/후진 제어 버튼을 눌러줍니다.

제어 버튼이 중앙에 있으면 공구가 꺼진 상태로 잠기게 됩니다. 제어 버튼의 위치를 변경할 때는 반드시 트리거를 놓아야 합니다.

**참고:** 회전 방향을 변경한 후 처음으로 공구를 실행하면 작동 시 '딸깍' 소리가 들립니다. 이는 정상적 현상이며 고장이 아닙니다.

## 토크 조절 칼라(그림 1)

공구에는 다양한 모양과 크기의 잠금장치를 조이거나 제거하기 위한 변동형 토크 드라이버 메커니즘이 갖추어져 있고, 일부 모델에는 드릴과 석재를 위해 해머 메커니즘이 있습니다. 칼라(c)를 회전시키는 것은 숫자이고, 일부 모델에서는 드릴

비트 기호, 해머 기호가 있습니다. 이 숫자는 토크 범위를 제공할 클러치를 설정하는 데 사용됩니다. 칼라 숫자가 높을수록 조절 수 있는 잠금장치와 토크 수치가 높아집니다. 임의의 숫자를 선택하려면 원하는 숫자가 화살표와 맞을 때까지 회전하십시오.

## 이중 범위 기어링(그림 1)

드릴/드라이버의 이중 범위 기능을 통해 기어를 바꿔서 다양한 기능을 발휘할 수 있습니다.

1. 속도 1을 선택하려면(높은 토크 설정값) 공구를 꺼서 멈추게 합니다. 기어 변속장치(d)를 앞쪽으로 밀니다(적 방향으로).
2. 속도 2(낮은 토크 설정값)을 선택하려면 공구를 꺼서 정지시킵니다. 기어 변속장치를 뒤로 밀니다(적에서 멀리).

**참고:** 공구가 작동 중인 경우에는 기어를 변경하지 마십시오. 기어를 변경하기 전에 항상 드릴이 완전히 멈추었는지 확인하십시오. 기어를 변경하는 데 문제가 있으면 이중 범위 기어 변속장치를 완전히 앞으로 밀었는지 또는 완전히 뒤로 밀었는지 확인하십시오.

## 작업등(그림 1)

작업등(e)은 트리거 스위치(a) 바로 위에 있습니다. 작업등은 트리거 스위치를 누르면 작동합니다. 트리거 스위치를 놓으면 작업등이 최대 20초 동안 점등되어 있습니다.

**참고:** 작업등은 인접한 작업대를 비추기 위한 것이며 손전등으로 사용하기 위한 것이 아닙니다.

## 키리스 단일 슬리브 척 (그림 7-9)



**경고:** 척의 앞부분을 쥐고 공구를 켜는 식으로 드릴 비트(또는 다른 모든 액세서리)를 조이지 마십시오. 척이 손상되거나 신체 부상을 초래할 수 있습니다. 액세서리를 변경할 때는 항상 트리거 스위치를 잠그고 전원에서 공구 플러그를 빼십시오.



**경고:** 공구를 시작하기 전에 항상 비트가 고정되어 있는지 확인하십시오. 비트가 느슨하면 공구에서 빠져 신체 부상을 초래할 수 있습니다.

본 공구에는 키가 필요없는 척(f)이 사용되며 척을 한 손으로 작동시킬 수 있게 단일 회전 슬리브가 제공됩니다. 드릴 비트 또는 기타 액세서리를 삽입하려면 다음 단계를 따르십시오.

1. 공구를 고고 전원에서 공구 플러그를 뽑니다.

2. 한 손으로 척의 검은색 슬리브를 잡고 다른 손을 사용해서 공구를 고정합니다. 원하는 액세서리를 수용할 수 있도록 슬리브를 시계 반대 방향으로 충분히 돌립니다.
3. 한 손으로 공구를 잡으면서 다른 손으로 척 슬리브를 시계 방향으로 회전시켜 액세서리를 척으로 19 mm (3/4 inch) 정도 삽입하고 단단하게 조입니다. 공구에는 자동 스프링들 잠금 기계 장치가 장착되어 있습니다. 이를 통해 한 손으로 척을 열고 닫을 수 있습니다.

척 슬리브에서 한 손으로 척을 조이고 다른 손으로 공구를 잡아 최대한 조이십시오.

액세서리를 풀려면 위의 1단계와 2단계를 반복하십시오.

## 작동

### 사용 지침



**경고:** 안전 지시 사항과 해당 규정을 항상 준수하십시오.



**경고: 심각한 신체 부상의 위험을 줄이려면 공구를 조정하거나 부착물 또는 액세서리를 제거/설치하기 전에 공구를 끄고 배터리 팩을 분리하십시오.** 공구가 갑자기 작동하여 부상을 당할 수 있습니다.

### 올바른 손의 위치(그림 3)



**경고:** 심각한 신체 부상의 위험을 줄이려면 항상 그림과 같이 올바른게 손을 위치하십시오.



**경고:** 심각한 부상의 위험을 줄이려면 항상 급작스러운 반동을 예상하고 확실하게 잡으십시오.

올바른 손의 위치가 되려면 그림과 같이 한 손은 드릴을 잡고, 다른 손은 주 핸들(1)을 잡습니다.

### 드라이버 조작(그림 4)

1. 속도와 토크를 계획된 작업과 일치시키려면 이중 범위 기어 셀렉터를 사용하여 원하는 속도/토크 범위를 선택하십시오.
2. 토크 조절 칼라(2)를 원하는 위치로 돌립니다. 낮은 숫자는 낮은 토크 설정을 나타내고, 높은 숫자는 높은 토크 설정을 나타냅니다.
3. 비트를 드릴하면서 원하는 잠금장치 액세서리를 척에 끼웁니다.
4. 클러치 칼라의 적절한 위치를 결정하려면 스크랩 또는 확인 안된 영역에서 실제로 몇 번 실행해 보십시오.

5. 항상 낮은 토크 설정부터 시작한 후 더 높은 토크 설정으로 진행하여 작업장 또는 잠금장치가 되지 않도록 하십시오.

### 드릴 조작(그림 5)



**경고:** 심각한 신체 부상의 위험을 줄이려면 부착물 또는 액세서리를 조정하거나 제거/설치하기 전에 공구를 끄고 전원에서 공구 플러그를 뽑으십시오.



**경고: 신체 부상의 위험을 줄이려면 항상 작업물이 영거나 클램프로 단단히 고정되어 있는지 확인하십시오.** 얇은 재재를 드릴하는 경우, 재료가 손상되지 않도록 나무 “지지” 블럭을 사용하십시오.

1. 칼라(3)를 드릴 기호까지 돌립니다.
  2. 속도와 토크를 계획된 작업과 일치시키려면 기어 번속장치를 사용하여 원하는 속도/토크 범위를 선택하십시오.
  3. 나무의 경우 트윈스트 비트, 스페이드 비트, 파워 오거 비트 또는 원통톱을 사용하십시오. 금속의 경우 고속 스틸 트윈스트 드릴 비트 또는 원통톱을 사용하십시오. 금속 드릴 작업 시에는 절삭 윤활유를 사용하십시오. 건조 상태로 드릴 작업을 해야 하는 주철과 황동의 경우는 예외입니다.
  4. 항상 비트에 직선으로 압력을 가하십시오. 드릴이 작업물을 파고들기에 충분한 압력을 가하되, 모터 또는 비트가 변형될 정도로 강한 압력을 가하지 마십시오.
  5. 드릴의 비틀림 작용을 지탱할 수 있도록 두 손으로 공구를 단단하게 잡으십시오. 모델이 사이드 핸들에 장착되지 않으면 한 손은 핸들에, 다른 손은 배터리 팩에 놓고 드릴을 잡으십시오.
- 주의:** 파부화되어 급작스럽게 휘면 드릴이 고착될 수 있습니다. 고착되는 상황에 늘 대비하십시오. 드릴을 단단히 잡아서 휘는 작용을 제어하고 부상을 당하지 않도록 주의하십시오.
6. **드릴의 회전이 멈추는 경우는 일반적으로 파부하가 걸렸거나 부적합하게 사용했기 때문입니다. 트리거를 즉시 놓고, 작업 대상으로부터 드릴 비트를 제거한 다음 회전이 멈춘 원인을 해결하십시오. 회전이 멈춘 드릴을 다시 작동시키기 위해 트리거를 당기고 놓는 동작을 취하지 마십시오. 드릴 손상의 원인이 됩니다.**

7. 자재를 뿜는 동안 비트의 회전이 멈추거나 비트가 부러지지 않도록 구멍의 마지막 부분에서 압력을 줄이고 홀에서 비트를 부드럽게 빼내십시오.
8. 뿜린 구멍 밖으로 비트를 빼낼 때 모터를 가동 상태로 유지하십시오. 그래야 걸림 현상이 방지됩니다.
9. 가변 속도 드릴을 이용하면 드릴 작업할 지점에 센터 펀치 작업을 할 필요가 없습니다. 드릴 작업 시에는 낮은 속도로 시작했다가, 드릴이 밖으로 밀려나지 않고 구멍을 뿜기에 충분한 깊이의 구멍이 생기면 트리거를 더욱 강하게 잡아당겨 속도를 높이십시오.

## 해머 드릴 조작(그림 6)

### DCD776

1. 칼라(c)를 해머 드릴 기호까지 돌립니다.
2. 셀렉터(척에서 멀리)를 뒤로 밀어 고속 설정을 선택합니다.  
**중요:** 카바이드 팁 또는 석재 비트만 사용하십시오.
3. 해머가 과도하게 튀거나 비트에서 빠져 "올라가지" 않도록 적당한 힘으로만 드릴하십시오. 힘을 너무 주게 되면 드릴 속도가 느려지거나 과열이 발생할 수 있습니다.
4. 비트가 올바른 각도로 작업되도록 똑바로 드릴하십시오. 드릴 작업 시에는 비트에 사이드 압력을 가하지 마십시오. 비트의 나선형 홈이 막히거나 드릴 속도가 느려질 수 있습니다.
5. 구멍을 깊게 드릴할 때 해머 속도가 떨어지기 시작하면 아직 가동 중인 공구를 사용하여 구멍 밖으로 비트를 일부 빼내어 구멍 안에 먼지가 쌓이지 않도록 하십시오.

**참고:** 먼지가 균일하고 구멍에서 부드럽게 빠져나오면 드릴 속도가 적당한 것입니다.

## 유지 보수

DEWALT 전동 공구는 최소한의 유지 보수로 장기간에 걸쳐 작업이 가능하도록 설계되어 있습니다. 만족스러운 연속 작동은 적절한 공구 관리와 정기적인 청소에 따라 그 성능이 달라질 수 있습니다.



**경고: 심각한 신체 부상의 위험을 줄이려면 공구를 조정하거나 부착물 또는 액세서리를 제거/설치하기 전에 공구를 끄고 배터리 팩을 분리하십시오.** 공구가 갑자기 작동하여 부상을 당할 수 있습니다.

충전기 및 배터리 팩은 수리 해당 품목에서 제외됩니다. 내부에 수리할 수 있는 부품이 없습니다.



## 윤활방법

전동 공구는 별도의 윤활 작업이 필요하지 않습니다.



## 청소



**경고:** 동풍구 속이나 주변에 먼지가 쌓여있는 것이 보이면 가능한 한 자주 건조한 공기를 이용하여 몸체에서 먼지를 불어내십시오. 이 절차를 수행할 때에는 승인된 눈 보호 장구 및 승인된 방진 마스크를 착용하십시오.



**경고:** 공구의 금속 이외의 부품을 청소할 때는 용제 등의 강력한 화학약품을 절대 사용하지 마십시오. 그렇지 않으면 이러한 부분에 사용된 재료가 약해질 수 있습니다. 헹굼에 물과 순한 비누를 적셔 닦아주십시오. 공구 내부에 액체를 넣거나 공구 부품을 액체에 담그는 행동은 절대 금물입니다.

## 충전기 청소 지침



**경고:** 감전 위험. 청소하려면 먼저 충전기를 AC 콘센트에서 분리하십시오. 헹굼이나 부드러운 금속 이외의 브러시로 충전기 외판 부분에 묻은 먼지 및 기름을 제거할 수 있습니다. 물이나 세제를 사용하지 마십시오.

## 옵션 액세서리



**경고:** DEWALT에서 제공하지 않은 액세서리는 본 제품에서 테스트되지 않았으므로 본 공구에서 이러한 액세서리를 사용하면 위험할 수 있습니다. 신체 부상의 위험을 줄이려면 본 제품에 DEWALT 권장 액세서리만 사용해야 합니다.

해당 액세서리에 대한 자세한 정보는 판매 대리점으로 문의하십시오.

## 환경 보호



분리 수거하십시오. 본 제품을 일반 가정용 쓰레기로 처리하면 안됩니다.

■ DeWALT 제품을 교체해야 하거나 더 이상 쓸모가 없어졌다고 판단될 때는 본 제품을 가정용 쓰레기와 함께 처리하지 마십시오. 이 제품은 분리 수거하십시오.



사용하던 제품과 포장을 분리 수거하면 자원을 재활용 및 재사용할 수 있습니다. 재활용 자원을 이용하면 환경 오염이 방지되고 고철 자원에 대한 수요를 줄일 수 있습니다.

지역에 따라 가정용 가전제품을 분리 수거하는 규정이 마련되어 있거나 새로운 제품을 구입할 때 판매점에서 폐기 방법을 알려줄 수 있습니다.

DeWALT는 제품 수명이 다하면 DeWALT 제품의 수거 및 재활용을 위한 시설을 제공하고 있습니다. 이 서비스를 활용하려면 당사가 폐 제품 수거를 위임한 공인 수리 대리점에 제품을 반환해 주십시오.

본 사용 설명서에 기재된 연락처로 가까운 DeWALT 영업소에 연락하면 가까운 공인 수리 대리점 위치를 확인할 수 있습니다. 또는 다음 웹 사이트를 방문하여 DeWALT 공인 수리 대리점 목록과 A/S 및 연락처 등 자세한 정보를 찾아볼 수 있습니다. [www.dewalt.co.kr](http://www.dewalt.co.kr).



## 충전용 배터리 팩

이전에 쉽게 수행했던 작업에 대해 충분한 힘을 발휘하지 못하는 배터리 팩은 재충전해야 합니다. 배터리 수명이 다하면 환경 보호 차원에서 배터리 팩을 폐기하십시오.

- 배터리 팩을 완전히 사용하고 난 후 공구에서 분리하십시오.
- 리튬 이온 전지는 재활용 가능합니다. 이 전지를 판매점이나 지역 재활용 센터로 가져가십시오. 수집된 배터리 팩은 재활용되거나 적절히 폐기됩니다.



# BOR/OBENG/BOR PALU Kompak Nirkabel 13 MM (1/2") DCD734, DCD771, DCD776

## Selamat!

Anda sudah memilih alat DEWALT. Pengalaman bertahun-tahun, pengembangan produk menyeluruh, dan inovasi, menjadikan DEWALT salah satu rekan paling andal bagi para pengguna alat listrik profesional.

## Data Teknis

		DCD734	DCD771	DCD776
Voltase	$V_{DC}$	14,4	18	18
Tipe		1	1	1
Tipe Baterai		Li-ION	Li-ION	Li-ION
Output daya	W	250	300	300
Kecepatan tanpa beban				
gigi satu	$\text{min}^{-1}$	0-400	0-450	0-450
gigi dua	$\text{min}^{-1}$	0-1300	0-1500	0-1500
Taraf tumbukan				
gigi satu	$\text{min}^{-1}$	–	–	0-7650
gigi dua	$\text{min}^{-1}$	–	–	0-25 500
Torsi maksimum (keras/lunak)	Nm	38/22	42/24	42/24
Kapasitas gagang gerak	mm	13	13	13
Kapasitas pengeboran maksimum				
Kayu	mm	30	30	30
Logam	mm	10	13	13
Batuan	mm	–	–	13
Berat (tanpa baterai)	kg	1,2	1,3	1,34

Baterai		DCB140	DCB141	DCB142	DCB143	DCB145
Tipe baterai		Li-ION	Li-ION	Li-ION	Li-ION	Li-ION
Voltase	$V_{DC}$	14,4	14,4	14,4	14,4	14,4
Kapasitas	$A_h$	3,0	1,5	4,0	2,0	1,3
Berat	kg	0,53	0,30	0,54	0,30	0,30

Baterai		DCB185	DCB181	DCB183	DCB180	DCB182
Tipe baterai		Li-ION	Li-ION	Li-ION	Li-ION	Li-ION
Voltase	$V_{DC}$	18	18	18	18	18
Kapasitas	$A_h$	1,3	1,5	2,0	3,0	4,0
Berat	kg	0,35	0,35	0,40	0,64	0,61

Pengisi daya		DCB107				
Voltase listrik	$V_{AC}$	230 V				
Tipe baterai		Li-ION				
Kisaran waktu pengisian daya	min	60	70	90	140	185
		(baterai 1,3 Ah)	(baterai 1,5 Ah)	(baterai 2,0 Ah)	(baterai 3,0 Ah)	(baterai 4,0 Ah)
Berat	kg	0,49				

## Definisi: Pedoman Keselamatan

Definisi berikut ini menjelaskan tingkat bahaya untuk setiap kata sinyal. Harap baca buku petunjuk dan perhatikan simbol-simbol ini.



**BAHAYA:** Mengindikasikan situasi berbahaya yang tak terelakkan, yang jika tidak dihindari, akan mengakibatkan **kematian atau cedera berat**.



**PERINGATAN:** Mengindikasikan situasi berbahaya yang berpotensi terjadi, yang jika tidak dihindari, **dapat** mengakibatkan **kematian atau cedera berat**.



**PERHATIAN:** Mengindikasikan situasi berbahaya yang berpotensi terjadi, yang jika tidak dihindari, **dapat** mengakibatkan **cedera ringan atau sedang**.

**PEMBERITAHUAN:** Mengindikasikan suatu praktik yang **tidak berhubungan dengan cedera diri**, yang jika tidak dihindari, **mungkin** mengakibatkan **kerusakan barang**.



Menunjukkan adanya risiko sengatan listrik.



Menunjukkan risiko kebakaran.



**PERINGATAN:** Untuk mengurangi risiko cedera, baca buku petunjuk manual.

## Peringatan Keselamatan Alat Listrik Umum



**PERINGATAN!** Baca seluruh peringatan keselamatan dan seluruh petunjuk. Kegagalan untuk mengikuti peringatan dan instruksi dapat mengakibatkan sengatan listrik, kebakaran, dan/atau cedera berat.

### SIMPAN SEMUA PERINGATAN DAN PETUNJUK UNTUK REFERENSI DI MASA MENDATANG

Istilah "alat listrik" dalam peringatan merujuk pada alat listrik beroperasi listrik induk (berkabel) atau alat listrik beroperasi baterai (nirkabel).

#### 1) KESELAMATAN AREA KERJA

- Jaga agar area kerja tetap bersih dan terang.** Area yang berantakan atau gelap berpotensi mengakibatkan kecelakaan.
- Jangan operasikan alat listrik di lingkungan yang dapat meledak, misalnya jika terdapat cairan, gas, atau debu yang mudah terbakar.** Alat listrik menimbulkan percikan api yang dapat menyulut debu atau uap.
- Jauhkan anak-anak dan orang-orang di sekitar Anda saat mengoperasikan alat listrik.** Gangguan dapat menyebabkan Anda kehilangan kendali.

#### 2) KESELAMATAN KELISTRIKAN

- Steker alat listrik harus sesuai dengan stopkontak. Jangan pernah memodifikasi steker dengan cara apa pun. Jangan gunakan steker adaptor apa pun dengan alat listrik yang dibumikan (grounded).** Steker yang tidak dimodifikasi dan stopkontak yang sesuai akan mengurangi risiko sengatan listrik.
- Jagalah agar badan Anda tidak bersentuhan dengan permukaan yang dibumikan, seperti pipa, radiator, kompor, dan kulkas.** Risiko sengatan listrik dapat meningkat jika tubuh Anda bersentuhan dengan permukaan yang dibumikan.
- Jangan sampai alat listrik ini terkena hujan atau terpapar pada kondisi yang basah.** Air yang masuk ke alat listrik akan meningkatkan risiko sengatan listrik.
- Jangan menyalahgunakan kabel. Jangan sekali-kali menggunakan kabel untuk membawa, menarik, atau mencabut alat listrik. Jauhkan kabel dari panas, minyak, tepi tajam, atau komponen yang bergerak.** Kabel yang rusak atau terbelit meningkatkan risiko sengatan listrik.
- Bila mengoperasikan alat listrik di luar ruangan, gunakan kabel ekstensi yang sesuai untuk penggunaan di luar ruangan.** Menggunakan kabel yang sesuai untuk penggunaan di luar ruangan akan mengurangi risiko sengatan listrik.
- Jika terpaksa mengoperasikan alat listrik di lokasi lembap, gunakan catu daya yang dilindungi pemutus sirkuit arus sisa (RCD).** Penggunaan RCD akan mengurangi risiko sengatan listrik.

#### 3) KESELAMATAN DIRI

- Tetaplah waspada, perhatikan apa yang Anda tengah kerjakan dan gunakan akal sehat saat mengoperasikan alat listrik. Jangan mengoperasikan alat listrik bila Anda sedang lelah, atau berada di bawah pengaruh obat, alkohol, atau pengobatan.** Kelengahan sesaat saja saat mengoperasikan alat listrik dapat mengakibatkan cedera diri serius.
- Gunakan peralatan pelindung diri. Selalu kenakan alat pelindung mata.** Peralatan pelindung, seperti masker debu, sepatu keselamatan antiselip, helm proyek, atau pelindung telinga yang digunakan untuk kondisi yang sesuai akan mengurangi risiko cedera diri.
- Hindarkan menyalakan alat tanpa disengaja. Pastikan bahwa sakelar sudah dalam posisi mati sebelum menghubungkannya ke sumber listrik dan/atau baterai, mengambil, atau membawa alat.** Membawa alat listrik dengan jari Anda masih menempel pada tombol atau menghidupkan alat listrik yang tombolnya masih menyala akan berpotensi mengakibatkan kecelakaan.
- Lepaskan semua kunci setelan atau kunci pas sebelum menghidupkan alat listrik. Kunci pas atau**

kunci yang dibiarkan terpasang pada komponen alat listrik yang berputar dapat mengakibatkan cedera diri.

- e) **Jangan melampaui batas. Selalu jaga pijakan dan keseimbangan yang baik.** Hal ini memungkinkan Anda untuk mengendalikan alat listrik secara lebih baik dalam situasi yang tidak terduga.
- f) **Kenakan pakaian yang sesuai. Jangan mengenakan pakaian longgar atau perhiasan. Jauhkan rambut, pakaian dan sarung tangan dari komponen yang bergerak.** Pakaian yang longgar, perhiasan atau rambut panjang dapat tersangkut pada komponen yang bergerak.
- g) **Jika disediakan perangkat untuk sambungan fasilitas pengeluaran dan pengumpulan debu, pastikan perangkat ini dihubungkan dan digunakan dengan sesuai.** Penggunaan alat pengumpul debu dapat mengurangi bahaya yang ditimbulkan oleh debu.

#### 4) PENGGUNAAN DAN PERAWATAN ALAT LISTRIK

- a) **Jangan menggunakan alat listrik dengan paksa. Gunakan alat listrik yang sesuai untuk aplikasi Anda.** Alat listrik yang tepat akan bekerja lebih baik dan aman pada tingkat kelajuan yang telah dirancang untuk alat itu.
- b) **Jangan gunakan alat listrik ini jika tombol tidak dapat menghidupkan dan mematikan alat.** Alat listrik apa pun yang tidak dapat dikendalikan dengan sakelar adalah berbahaya dan harus diperbaiki.
- c) **Lepaskan stopkontak dari sumber listrik dan/ atau baterai dari alat listrik sebelum melakukan penyetulan apa pun, mengganti aksesori, atau menyimpan alat listrik.** Tindakan pencegahan untuk keselamatan seperti itu akan mengurangi risiko menyalakan alat listrik secara tidak disengaja.
- d) **Simpan alat listrik yang tidak digunakan jauh dari jangkauan anak-anak, dan jangan membolehkan orang yang tidak memahami alat listrik atau petunjuk ini untuk mengoperasikannya.** Alat listrik dapat berbahaya bila digunakan oleh pengguna yang tidak terlatih.
- e) **Rawat alat listrik. Lakukan pemeriksaan untuk mengetahui apakah ada komponen bergerak yang tidak sejajar atau bengkok, komponen yang patah, dan kondisi lainnya yang dapat mempengaruhi pengoperasian alat listrik. Jika rusak, perbaiki alat listrik sebelum digunakan.** Banyak terjadi kecelakaan akibat alat listrik yang tidak terawat dengan baik.
- f) **Jaga ketajaman dan kebersihan alat pemotong.** Alat pemotong yang terawat dengan baik dengan mata potong yang tajam akan kecil kemungkinannya untuk macet serta lebih mudah untuk dikendalikan.
- g) **Gunakan alat listrik, aksesori, dan mata bor, dsb. sesuai instruksi-instruksi ini, dengan memperhitungkan persyaratan kerja dan jenis pekerjaan yang harus dilakukan.** Penggunaan alat

listrik untuk pengoperasian yang tidak sesuai dengan tujuan penggunaan dapat mengakibatkan situasi yang berbahaya.

#### 5) PENGGUNAAN DAN PERAWATAN ALAT BERTENAGA BATERAI

- a) **Isi ulang daya baterai dengan pengisi daya yang ditetapkan oleh pabrikan.** Pengisi daya yang cocok untuk satu tipe baterai dapat menimbulkan risiko kebakaran jika digunakan pada baterai lainnya.
- b) **Gunakan alat hanya dengan baterai yang ditujukan secara khusus.** Penggunaan baterai lainnya dapat menimbulkan risiko cedera dan kebakaran.
- c) **Pada saat baterai tidak dipakai, jauhkan baterai dari benda logam seperti klip penjepit kertas, koin, kunci, paku, sekrup, atau benda logam kecil lainnya yang dapat menghubungkan satu terminal dengan terminal lainnya.** Menghubungkan kedua terminal baterai dengan kabel secara tidak semestinya dapat mengakibatkan luka bakar atau kebakaran.
- d) **Pemakaian yang salah bisa menyebabkan keluarnya cairan dari baterai; hindari kontak. Jika tidak sengaja tersentuh, bilas dengan air. Jika cairan mengenai mata, carilah juga bantuan medis.** Cairan yang keluar dari baterai dapat menyebabkan iritasi atau luka bakar.

#### 6) SERVIS

- a) **Alat listrik sebaiknya diservis oleh teknisi yang mahir dan hanya menggunakan komponen pengganti yang persis sama.** Hal ini akan membuat keamanan alat listrik selalu terjaga.

### Aturan Keselamatan Tambahan Khusus untuk Bor/Obeng/Bor Palu

- **Gunakan pelindung telinga saat melakukan pengeboran tumbuk.** Paparan terhadap kebisingan dapat menyebabkan kehilangan pendengaran.
- **Gunakan pegangan tambahan, bila disertakan dengan alat ini.** Lepasnya kendali dapat menimbulkan cedera diri.
- **Pegang alat listrik pada permukaan pegangan berpenyekat saat melakukan pengoperasian di mana aksesori pemotong dapat bersentuhan dengan kabel tersembunyi.** Aksesori pemotong yang bersentuhan dengan kabel bertegangan listrik dapat mengalirkan arus listrik pada komponen logam alat listrik dan mengakibatkan sengatan listrik pada pengguna.
- **Gunakan jepitan atau cara praktis lain untuk mengamankan dan menyangga benda yang dikerjakan pada landasan yang stabil.** Memegang benda yang dikerjakan dengan tangan atau disandarkan pada tubuh Anda akan membuatnya tidak stabil dan dapat mengakibatkan hilangnya kendali.

- **Gunakan kacamata pengaman atau pelindung mata lainnya.** Operasi penempaan dan pengeboran mengakibatkan serpihan beterbangan. Partikel-partikel yang beterbangan dapat mengakibatkan cedera mata permanen.
- **Aksesori dan alat dapat menjadi panas selama pengoperasian.** Gunakan sarung tangan saat menanganinya jika melakukan aplikasi produksi panas seperti pengeboran tempat dan pengeboran logam.
- **Jangan operasikan alat ini untuk jangka waktu yang lama.** Getaran akibat kerja palu dapat mencederai tangan dan lengan Anda. Gunakan sarung tangan sebagai bantalan tambahan dan batasi paparan dengan cara sering melakukan pengistirahatan.
- **Lubang ventilasi sering menutupi komponen yang bergerak dan harus dihindari.** Pakaian yang longgar, perhiasan atau rambut panjang dapat tersangkut pada komponen yang bergerak.

## Risiko-risiko lain

Risiko-risiko ini rentan terjadi dalam penggunaan bor:

- Cedera yang dikarenakan menyentuh komponen yang berputar atau komponen alat yang panas.

Sekalipun peraturan keselamatan terkait sudah diterapkan dan peralatan pengaman sudah digunakan, risiko-risiko lain tertentu tidak dapat dihindari. Antara lain:

- Kerusakan indera pendengaran.
- Risiko jari terjepit saat mengganti aksesori.
- Ancaman kesehatan akibat menghirup debu yang dihasilkan saat bekerja dengan kayu.
- Risiko cedera pribadi karena partikel-partikel yang beterbangan.
- Risiko cedera pribadi karena penggunaan berkepanjangan.

## Tanda pada Alat

Gambar-gambar berikut ini tertera pada alat:



Baca buku petunjuk sebelum penggunaan.

### POSISI KODE TANGGAL (GBR. 1)

Kode Tanggal (j), juga menyebutkan tahun pembuatan, tercetak di permukaan alat pada engsel pemasangan antara alat dan baterai.

Contoh:

2014 XX XX

Tahun Pembuatan

## Petunjuk Keselamatan Penting untuk Semua Pengisi Daya Baterai

**SIMPAN PETUNJUK-PETUNJUK INI:** Buku petunjuk ini mencantumkan petunjuk keselamatan dan pengoperasian penting untuk pengisi daya baterai DCB107.

- Sebelum menggunakan pengisi daya, baca seluruh petunjuk dan tanda peringatan pada pengisi daya, baterai, dan produk menggunakan baterai.



**PERINGATAN:** Bahaya sengatan listrik. Jaga agar tidak ada cairan masuk ke dalam pengisi daya. Ini dapat mengakibatkan sengatan listrik.



**PERHATIAN:** Bahaya terbakar. Untuk mengurangi risiko cedera, hanya lakukan pengisian daya untuk baterai DeWALT yang dapat diisi daya. Tipe-tipe baterai lainnya dapat menjadi terlalu panas dan meledak, mengakibatkan cedera diri dan kerusakan barang.



**PERHATIAN:** Anak-anak harus diawasi agar mereka tidak bermain-main dengan peralatan ini.

**PEMBERITAHUAN:** Dalam kondisi tertentu, saat pengisi daya terhubung dengan catu daya, kontak pengisian daya terarah dalam pengisi daya dapat korslet karena adanya benda asing. Benda-benda asing bersifat penghantar listrik semacam ini dapat berupa, namun tidak terbatas pada: serat baja, kertas aluminium, atau tumpukan partikel-partikel logam, yang semuanya harus dijauhkan dari rongga-rongga pengisi daya. Selalu cabut pengisi daya dari catu daya bilamana tidak ada baterai dalam rongga. Cabut pengisi daya sebelum membersihkannya.

- **JANGAN berusaha mengisi daya baterai dengan pengisi daya apa pun lainnya selain yang disebutkan dalam buku petunjuk ini.** Pengisi daya dan baterai dirancang khusus untuk digunakan bersama.
- **Pengisi daya ini tidak ditujukan untuk penggunaan lainnya selain mengisi daya baterai DeWALT yang dapat diisi daya ulang.** Penggunaan lain dapat mengakibatkan risiko kebakaran, sengatan listrik, atau kematian karena sengatan listrik.
- **Jangan paparkan pengisi daya pada hujan atau salju.**
- **Cabut steker, bukan kabel, pada saat melepas pengisi daya.** Ini akan mengurangi risiko kerusakan steker dan kabel listrik.
- **Pastikan letak kabel sudah aman agar tidak terinjak, menyebabkan tersandung, atau rentan rusak atau tertekan.**

- **Jangan gunakan kabel sambungan kecuali jika mutlak diperlukan.** Penggunaan kabel sambungan yang tidak tepat dapat mengakibatkan risiko kebakaran, sengatan listrik, atau kematian akibat sengatan listrik.
- **Saat mengoperasikan pengisi daya di luar ruangan, selalu sediakan tempat yang kering dan gunakan kabel sambungan yang cocok untuk penggunaan luar ruangan.** Menggunakan kabel yang sesuai untuk penggunaan di luar ruangan akan mengurangi risiko sengatan listrik.
- **Jangan tutup celah ventilasi pengisi daya. Celah ventilasi terletak pada bagian atas dan samping pengisi daya.** Posisikan pengisi daya jauh dari sumber panas apa pun.
- **Jangan operasikan pengisi daya dengan kabel atau steker yang rusak** — segera ganti.
- **Jangan gunakan pengisi daya apabila telah terbantam keras, jatuh, atau rusak dengan cara apa pun.** Bawa ke pusat servis resmi.
- **Jangan bongkar pengisi daya; bawa ke pusat servis resmi bilamana membutuhkan servis atau reparasi.** Perakitan ulang yang keliru dapat mengakibatkan risiko sengatan listrik, kematian akibat sengatan listrik, atau kebakaran.
- **Jika yang rusak adalah kabel catu daya, maka harus segera diganti oleh pabrik pembuat, agen servisnya, atau teknisi ahli serupa untuk mencegah bahaya apa pun.**
- **Lepas pengisi daya dari stopkontak sebelum dibersihkan. Ini akan mengurangi risiko sengatan listrik.** Melepaskan baterai tidak dapat mengurangi risiko ini.
- **JANGAN PERNAH menghubungkan 2 pengisi daya.**
- **Pengisi daya dirancang untuk beroperasi pada daya listrik rumah 230 V standar. Jangan pernah gunakan pada voltase lain.** Ini tidak berlaku bagi pengisi daya kendaraan.

**SIMPAN PETUNJUK-PETUNJUK INI**

**Pengisi daya**

Pengisi daya DCB107 dapat digunakan untuk baterai 10,8 V, 14,4 V, dan 18 V Li-ION (DCB121, DCB123, DCB125, DCB127, DCB140, DCB141, DCB142, DCB144, DCB145, DCB180, DCB181, DCB182, DCB183, DCB184, dan DCB185).

Pengisi daya ini tidak membutuhkan penyesuaian dan dirancang untuk dapat dioperasikan semudah mungkin.

**Prosedur Pengisian Daya (gambar 2)**







1. Sambungkan pengisi daya pada stopkontak 220-240V yang sesuai sebelum memasukkan baterai.

2. Masukkan baterai (g) ke pengisi daya, pastikan bahwa tersebut sudah terpasang sepenuhnya pada pengisi daya. Lampu merah (pengisian daya) akan terus berkedip, menandakan bahwa proses pengisian daya sudah dimulai.
3. Lampu merah akan MENYALA terus-menerus sebagai indikasi bahwa pengisian daya sudah selesai. Baterai sudah terisi daya penuh dan dapat digunakan sekarang, atau dibiarkan di dalam pengisi daya.

**CATATAN:** Untuk memastikan kinerja maksimum dan masa pakai baterai Li-ION, isi ulang daya baterai sampai penuh sebelum pemakaian pertama.

**Proses Pengisian Daya**

Lihat tabel di bawah ini untuk mengetahui status pengisian daya baterai.

Status pengisian daya—DCB107	
 mengisi daya	— — — — — 
 terisi penuh	— — — — — 
 penundaan baterai panas/dingin	— — — — — 

**PENUNDAAN BATERAI PANAS/DINGIN (DCB107)**

Pengisi daya DCB107 memiliki fitur penundaan panas/dingin. Ketika pengisi daya mendeteksi bahwa baterai panas, maka pengisi daya secara otomatis menunda pengisian daya sampai baterai telah menjadi dingin.

Ketika pengisi daya mendeteksi bahwa baterai dingin, maka pengisi daya secara otomatis menunda pengisian daya sampai baterai telah menjadi hangat.

Lampu merah akan terus berkedip, tapi lampu indikator kuning akan menyala selama operasi ini. Setelah baterai menjadi dingin, lampu kuning akan mati dan pengisi daya akan melanjutkan prosedur pengisian daya.

Alat XR Li-ION dirancang dengan Sistem Perlindungan Elektronik yang akan melindungi baterai dari kelebihan beban, suhu yang terlalu panas, dan kotoran yang membandel.

Alat akan mati secara otomatis bilamana Sistem Perlindungan Elektronik mulai bekerja. Jika ini terjadi, maka tempatkan baterai Li-ION pada pengisi daya sampai terisi daya penuh.

**Petunjuk Keselamatan Penting untuk Semua Baterai**

Saat memesan baterai pengganti, pastikan Anda menyebutkan nomor katalog dan voltase.

Baterai tidak sepenuhnya terisi di luar karton. Sebelum menggunakan baterai dan pengisi daya, baca petunjuk keselamatan di bawah ini dan ikuti prosedur pengisian daya sesuai penjelasan.

**BACA SELURUH PETUNJUK**

- **Jangan mengisi daya atau menggunakan baterai di lingkungan yang mudah menimbulkan bahaya**

ledakan, seperti di tempat yang terdapat cairan mudah terbakar, gas, atau debu. Memasukkan atau melepaskan baterai dari pengisi daya dapat membakar debu atau asap.

- **Jangan pernah memasukkan baterai ke dalam pengisi daya dengan paksa. Jangan memodifikasi baterai dengan cara apa pun untuk dapat dimasukkan ke dalam pengisi daya yang tidak sesuai, karena baterai dapat pecah dan mengakibatkan cedera diri yang berat.**
- **Isi daya baterai hanya menggunakan pengisi daya DeWALT yang ditentukan.**
- **JANGAN perbaiki atau rendam dengan air atau cairan lain.**
- **Jangan simpan atau pakai alat dan baterai di lokasi di mana suhu dapat mencapai atau melebihi 40°C (105°F) (seperti di bangsal luar atau bangunan logam pada musim panas).**
- **Untuk hasil terbaik, pastikan baterai telah terisi daya penuh sebelum digunakan.**



**PERINGATAN:** Jangan pernah berusaha membuka baterai untuk alasan apa pun. Jika kotak baterai retak atau rusak, jangan masukkan ke dalam pengisi daya. Jangan meremukkan, menjatuhkan, atau merusakkan baterai. Jangan gunakan baterai atau pengisi daya yang sudah terhantam keras, jatuh, terlindas, atau rusak dengan cara apa pun (misalnya: tertembus paku, terpukul palu, terinjak). Ini dapat mengakibatkan sengatan listrik atau kematian akibat sengatan listrik. Baterai yang rusak harus dikembalikan ke pusat layanan untuk didaur ulang.



**PERHATIAN:** Bila tidak sedang dipakai, tempatkan alat pada sisi sampingnya pada permukaan yang stabil agar tidak menyebabkan bahaya tersandung atau jatuh. Alat-alat dengan baterai besar dapat berdiri tegak pada baterai, namun mudah tersenggol jatuh.

**PETUNJUK KESELAMATAN KHUSUS UNTUK LITHIUM ION (Li-ION)**

- **Jangan bakar baterai sekalipun rusak parah atau aus sama sekali. Baterai dapat meledak jika terbakar. Baterai yang dibakar akan menimbulkan asap dan material beracun.**
- **Jika kandungan baterai bersentuhan dengan kulit, maka segera cuci bagian yang terkena dengan sabun lembut dan air. Jika cairan baterai masuk ke mata, basuh mata terbuka dengan air mengalir selama 15 menit atau sampai iritasi berhenti. Jika dibutuhkan penanganan medis, elektrolit baterai tersusun atas campuran karbonat organik cair dan garam lithium.**
- **Kandungan sel-sel baterai yang terbuka dapat mengakibatkan gangguan pernapasan. Cari udara**

segar. Jika gejala tidak berubah, cari bantuan medis.



**PERINGATAN:** Bahaya terbakar. Cairan baterai dapat terbakar jika terkena percikan api atau lidah api.

**Baterai**

**TIPE BATERAI**

DCD734 beroperasi pada baterai 14,4 volt.

DCD771 dan DCD776 beroperasi pada baterai 18 volt.

Baterai DCB140, DCB142, DCB143, DCB144, DCB145, DCB180, DCB181, DCB182, DCB183, DCB184, atau DCB185 dapat digunakan. Baca **Data Teknis** untuk informasi lebih lanjut.

**Saran Penyimpanan**

1. Tempat penyimpanan terbaik adalah tempat yang sejuk dan kering, jauh dari sinar matahari langsung dan suhu panas atau dingin berlebihan. Untuk kinerja dan masa pakai baterai optimum, simpan baterai pada suhu ruangan bilamana tidak digunakan.
2. Untuk penyimpanan jangka panjang, disarankan agar Anda menyimpan baterai yang terisi daya penuh di tempat yang sejuk dan kering, di luar pengisi daya, untuk hasil optimal.

**CATATAN:** Baterai tidak boleh disimpan dalam kondisi kosong tanpa diisi daya sama sekali. Baterai perlu diisi ulang daya sebelum digunakan.

**Label pada Pengisi Daya dan Baterai**

Sebagai tambahan gambar-gambar yang digunakan dalam buku petunjuk ini, label-label pada pengisi daya dan baterai menunjukkan gambar-gambar berikut ini:



Baca buku petunjuk sebelum penggunaan.



Mengisi ulang daya.



Terisi penuh.



Penundaan baterai panas/dingin.



Baterai atau pengisi daya bermasalah.



Sambungan listrik bermasalah.



Jangan bongkar dengan benda penghantar listrik.



Jangan mengisi daya baterai yang rusak.



Hanya gunakan dengan baterai DeWALT. Baterai lain dapat pecah, menyebabkan cedera diri dan kerusakan.



Jangan paparkan pada air.



Segera ganti kabel yang rusak.



Isi daya hanya antara 4 C dan 40 C.



Buang baterai dengan hati-hati agar tidak merusak lingkungan.



Jangan bakar baterai.



Isi daya baterai Li-ION.



Lihat **Data Teknis** untuk mengetahui lama pengisian daya.



Hanya untuk penggunaan dalam ruangan.

## Isi Kemasan

Kemasan memuat:

- 1 Bor/obeng atau 1 bor/obeng/bor palu
- 1 Pengisi daya
- 1 Baterai Li-ION (model C1)
- 2 Baterai Li-ION (model C2)
- 3 Baterai Li-ION (model C3)
- 1 Kotak perlengkapan
- 1 Buku petunjuk

**CATATAN:** Baterai, pengisi daya, dan kotak perlengkapan tidak disertakan dengan model-N.

- *Periksa kemungkinan adanya kerusakan pada alat, komponen, atau aksesoris yang bisa jadi terjadi selama transportasi.*
- *Luangkan waktu untuk membaca seluruh isi buku petunjuk ini dan memahaminya sebelum pengoperasian.*

## Penjelasan (gambar 1)



**PERINGATAN:** Jangan pernah memodifikasi alat listrik atau komponennya. Ini dapat mengakibatkan kerusakan atau cedera pribadi.

- a. Sakelar pemacu
- b. Tombol kendali maju/mundur
- c. Bantalan penyetelan torsi
- d. Pengatur roda gigi
- e. Lampu kerja
- f. Gagang gerak tanpa kunci
- g. Baterai
- h. Tombol pelepas baterai
- i. Pegangan utama

### TUJUAN PENGGUNAAN

Bor/obeng/bor palu ini dirancang untuk aplikasi pengeboran, pengeboran perkusi, dan pengobengan profesional.

**JANGAN** gunakan dalam kondisi basah atau di dekat cairan maupun gas yang mudah terbakar.

Bor/obeng/bor palu ini merupakan alat listrik profesional.

**JANGAN** biarkan anak-anak bersentuhan dengan alat ini. Dibutuhkan pengawasan bila alat ini digunakan oleh operator yang belum berpengalaman.

- Produk ini tidak ditujukan untuk penggunaan oleh orang (termasuk anak-anak) yang menderita kekurangan kemampuan fisik, sensorik, atau mental; kurang pengalaman, pengetahuan, atau keahlian, kecuali apabila mereka diawasi oleh orang yang bertanggung jawab atas keselamatan mereka. Jangan pernah meninggalkan anak-anak sendirian dengan produk ini.

### Keselamatan Kelistrikan

Motor listrik dirancang hanya untuk satu voltase. Selalu periksa apakah voltase baterai sesuai dengan voltase yang tercantum pada papan tarif (rating plate). Selain itu, pastikan bahwa voltase pengisi daya Anda sesuai dengan voltase induk.



Pengisi daya DeWALT Anda berisolasi ganda sesuai dengan IEC 60335; itu sebabnya kabel arde tidak diperlukan.

Bila kabel suplai rusak, harus diganti dengan kabel khusus yang disediakan oleh organisasi layanan DeWALT.

### Menggunakan Kabel Ekstensi

Kabel sambungan tidak semestinya digunakan, kecuali bila mutlak perlu. Gunakan kabel sambungan yang disetujui, yang sesuai untuk input daya pengisi daya Anda (lihat **Data Teknis**). Ukuran konduktor minimum 1 mm<sup>2</sup>; panjang maksimum 30 m.

Bila menggunakan gulungan kabel, selalu ulur kabel sepenuhnya.

## PERAKITAN DAN PENYESUAIAN



**PERINGATAN:** Untuk mengurangi risiko cedera diri yang berat, matikan alat dan lepas baterai sebelum melakukan penyesuaian apa pun atau melepaskan/memasang pelengkap atau aksesoris. Alat yang mendadak menyala dapat mengakibatkan cedera.



**PERINGATAN:** Gunakan hanya baterai dan pengisi daya DEWALT.

## Memasukkan dan Melepaskan Baterai dari Alat (gambar 2)



**PERINGATAN:** Sebelum merakit dan menyesuaikan, selalu lepaskan baterai lebih dulu. Selalu matikan alat sebelum memasukkan atau melepaskan baterai.

**CATATAN:** Untuk hasil terbaik, pastikan bahwa baterai Anda telah terisi daya penuh.

### CARA MEMASANG BATERAI PADA PEGANGAN ALAT

1. Sejajarkan baterai (g) dengan ruji-ruji di dalam pegangan alat (gambar 2).
2. Sorongkan ke dalam pegangan sampai baterai sudah pas betul pada alat dan pastikan bahwa baterai tidak terlepas.

### CARA MELEPASKAN BATERAI DARI ALAT

1. Tekan tombol pelepas baterai (h) dan tarik kuat baterai dari pegangan alat.
2. Masukkan baterai ke dalam pengisi daya sebagaimana dijelaskan dalam bagian pengisi daya buku petunjuk ini.

### BATERAI PENGUKUR BAHAN BAKAR (GAMBAR 2)

Beberapa baterai DEWALT memiliki pengukur bahan bakar yang terdiri dari tiga lampu LED hijau yang menunjukkan tingkat daya yang tersisa pada baterai.

Untuk mengaktifkan pengukur bahan bakar, tekan dan tahan tombol pengukur bahan bakar (k). Kombinasi dari tiga lampu LED hijau akan menyala yang menunjuk tingkat daya yang tersisa. Ketika tingkat daya pada baterai di bawah batas yang dapat digunakan, pengukur bahan bakar tidak akan menyala dan baterai harus diisi ulang.

**CATATAN:** Pengukur bahan bakar hanya menunjukkan daya yang tersisa pada baterai. Pengukur bahan bakar tidak menunjukkan fungsionalitas alat dan bisa bervariasi berdasarkan komponen produk, suhu, dan aplikasi pengguna akhir.

## Sakelar Pemicu Kecepatan Variabel (gambar 1)

Untuk menyalakan alat, tekan saklar pemicu (a). Untuk mematikan alat, lepaskan tombol pemicu. Alat Anda dilengkapi dengan rem. Gagang akan berhenti segera setelah saklar pemicu sepenuhnya dilepaskan.

**CATATAN:** Penggunaan terus-menerus dalam rentang kecepatan variabel tidak disarankan. Ini dapat merusak sakelar dan harus dihindari.

## Tombol Kendali Maju/Mundur (gambar 1)

Tombol kendali maju/mundur (b) menentukan arah alat dan juga berfungsi sebagai tombol pengunci.

Untuk memilih rotasi maju, lepaskan saklar pemicu dan tekan tombol kendali maju/mundur pada sisi kanan alat.

Untuk memilih rotasi mundur, tekan tombol kendali maju/mundur pada sisi kiri alat.

Posisi tengah tombol kendali mengunci alat dalam posisi mati. Saat mengubah posisi tombol kendali, pastikan bahwa pemicu sudah dilepaskan.

**CATATAN:** Saat pertama kali alat dijalankan setelah mengubah arah rotasi, Anda mungkin mendengar bunyi klik saat alat mulai bekerja. Ini normal dan tidak menunjukkan adanya masalah.

## Bantalan Penyetelan Torsi (gambar 1)

Alat Anda memiliki mekanisme obeng torsi yang dapat disesuaikan untuk memasukkan dan melepas berbagai bentuk dan ukuran penjepit dan dalam beberapa model, mekanisme palu untuk pengeboran batuan. Melingkari bantalan (c) merupakan angka-angka, simbol mata bor, dan pada beberapa model, simbol palu. Angka-angka ini digunakan untuk mengatur kopleng guna memberikan rentang torsi. Semakin tinggi angka pada bantalan, maka semakin tinggi torsi dan semakin besar penjepit yang dapat dimasukkan. Untuk memilih angka apa pun, putar hingga angka yang diinginkan sejajar dengan panah.

## Roda Gigi Rentang Ganda (gambar 1)

Dengan fitur rentang ganda dari bor/obeng/bor palu Anda, Anda dapat mengatur roda gigi untuk fleksibilitas yang lebih besar.

1. Untuk memilih kecepatan 1 (pengaturan torsi tinggi), matikan alat dan biarkan berhenti. Geser pengatur roda gigi (d) ke depan (ke arah gagang gerak).
2. Untuk memilih kecepatan 2 (pengaturan torsi rendah), matikan alat dan biarkan berhenti. Geser pengatur roda gigi ke belakang (menjauh dari gagang gerak).



**CATATAN:** Jangan ubah roda gigi saat alat sedang berjalan. Selalu pastikan bor benar-benar berhenti sebelum mengubah roda gigi. Jika Anda mengalami kesulitan mengubah roda gigi, pastikan bahwa pengatur roda gigi rentang ganda sepenuhnya ditekan ke depan atau sepenuhnya ditekan ke belakang.

## Lampu kerja (gambar 1)

Lampu kerja (e) terletak tepat di atas sakelar pemacu (a). Lampu kerja aktif saat sakelar pemacu ditekan. Saat pemacu dilepaskan, lampu kerja akan tetap menyala hingga 20 detik.

**CATATAN:** Lampu kerja dirancang untuk menerangi permukaan benda yang sedang dikerjakan dan tidak ditujukan untuk penggunaan sebagai lampu sorot.

## Gagang Gerek Lengan Tunggal Tanpa Kunci (gambar 7–9)



**PERINGATAN:** Jangan pernah mengencangkan mata bor (atau aksesoris apa pun) dengan cara memegang erat bagian depan gagang gerek dan menyalakan alat. Ini dapat mengakibatkan kerusakan gagang gerek dan cedera diri. Selalu kunci sakelar pemacu dan lepaskan alat dari sumber listrik saat mengganti aksesoris.



**PERINGATAN:** Selalu pastikan mata bor aman sebelum memulai alat. Mata bor yang longgar dapat lepas dari alat sehingga menyebabkan kemungkinan cedera diri.

Alat Anda memiliki gagang gerek tanpa kunci (f) dengan satu lengan pemutar untuk pengoperasian gagang gerek dengan satu tangan. Untuk memasukkan mata bor atau aksesoris lainnya, ikuti langkah-langkah berikut.

1. Matikan dan lepaskan alat dari sumber listrik.
2. Genggam lengan gagang gerek yang berwarna hitam dengan satu tangan dan gunakan tangan yang lain untuk mengamankan alat. Putar lengan berlawanan arah jarum jam cukup jauh untuk menerima aksesoris yang diinginkan.
3. Masukkan aksesoris sekitar 19 mm (3/4SDSq) ke dalam gagang gerek dan kencangkan dengan aman dengan memutar lengan gagang gerek searah jarum jam menggunakan satu tangan, sementara tangan yang lain memegang alat. Alat Anda dilengkapi dengan mekanisme penguncian poros otomatis. Ini memungkinkan Anda membuka dan menutup gagang gerek dengan satu tangan.

Pastikan untuk mengencangkan gagang gerek dengan satu tangan pada lengan gagang gerek dan tangan yang lain memegang alat untuk pengencangan maksimal.

Untuk melepaskan aksesoris, ulangi langkah 1 dan 2 di atas.

## PENGOPERASIAN

### Petunjuk Penggunaan



**PERINGATAN:** Selalu patuhi petunjuk keselamatan dan peraturan yang berlaku.



**PERINGATAN:** Untuk mengurangi risiko cedera diri yang berat, matikan alat dan lepas baterai sebelum melakukan penyesuaian apa pun atau melepaskan/memasang pelengkap atau aksesoris. Alat yang mendadak menyala dapat mengakibatkan cedera.

### Posisi Tangan yang Benar (gambar 3)



**PERINGATAN:** Untuk mengurangi risiko cedera diri yang serius, **SELALU** gunakan posisi tangan yang tepat sesuai petunjuk gambar.



**PERINGATAN:** Untuk mengurangi risiko cedera diri yang serius, **SELALU** pegang dengan erat untuk mengantisipasi reaksi mendadak.

Posisi tangan yang benar berarti satu tangan pada bagian atas bor sebagaimana ditunjukkan, dan tangan lainnya pada pegangan utama (i).

### Pengoperasian Obeng (gambar 4)

1. Pilih kecepatan/rentang torsi yang diinginkan menggunakan pemilih roda gigi rentang ganda untuk menyesuaikan kecepatan dan torsi operasi yang direncanakan.
2. Ubah bantalan penyetalan torsi (c) ke posisi yang diinginkan. Angka yang lebih rendah menunjukkan pengaturan torsi yang lebih rendah, angka yang lebih tinggi menunjukkan pengaturan torsi yang lebih tinggi.
3. Masukkan aksesoris pengencang yang diinginkan ke dalam gagang sama seperti cara memasukkan mata bor.
4. Buat beberapa kali percobaan pada potongan atau pada bidang yang tak terlihat untuk menentukan posisi batang koping yang tepat.
5. Selalu mulai dengan pengaturan torsi yang lebih rendah, kemudian maju ke pengaturan torsi yang lebih tinggi untuk menghindari kerusakan pada benda yang dikerjakan atau pengencang.

### Operasi Bor (gambar 5)



**PERINGATAN:** Untuk mengurangi risiko cedera pribadi yang berat, matikan alat dan lepaskan dari sumber listrik sebelum melakukan penyesuaian apa pun atau melepaskan/memasang pelengkap atau aksesoris.



**PERINGATAN:** Untuk mengurangi risiko cedera diri, **SELALU** pastikan bahwa bahan kerja sudah ditahan atau dijepit erat. Saat mengebor material tipis, gunakan balok kayu "penyangga" untuk mencegah rusaknya material.

1. Ubah bantalan (c) ke simbol bor.
2. Pilih kecepatan/rentang torsi yang diinginkan menggunakan pengatur roda gigi untuk menyesuaikan kecepatan dan torsi ke operasi yang direncanakan.
3. Untuk KAYU, gunakan mata bor ulir, mata bor pipih, mata bor kayu, atau gergaji pelubang. Untuk LOGAM, gunakan mata bor ulir baja atau gergaji pelubang kecepatan tinggi. Gunakan pelumas pemotong saat mengebor logam. Kecuali untuk besi tuangan dan kuningan yang harus dibor kering.
4. Selalu beri tekanan dalam garis lurus dengan mata bor. Gunakan cukup tekanan untuk menjaga agar mata bor tidak melenceng, namun jangan dorong terlalu kuat sampai motor macet atau mata bor rusak.
5. Pegang alat dengan erat menggunakan kedua tangan untuk mengendalikan kerja putaran bor. Jika model tidak dilengkapi dengan pegangan samping, maka pegang bor dengan satu tangan pada pegangan dan satu tangan pada baterai.



**PERHATIAN:** Bor mungkin macet jika kelebihan beban yang menyebabkan lilitan yang mendadak. Selalu antisipasi macet. Pegang bor dengan erat untuk mengendalikan kerja putaran bor dan menghindari cedera.

6. **JIKA BOR MACET**, biasanya karena dibebani berlebihan atau digunakan dengan tidak benar. **SEGERA LEPAS PEMICU**, lepaskan mata bor dari benda kerja, dan pastikan penyebab kemacetan. **JANGAN MENKLIK PEMICU BERULANG KALI UNTUK BERUSAHA MENYALAKAN BOR YANG MACET — INI DAPAT MERUSAK BOR.**
7. Untuk meminimalkan kemacetan atau kerusakan pada material, kurangi tekanan pada bor dan kendurkan mata bor melalui bagian pecahan lubang paling belakang.
8. Tetap jalankan motor saat menarik mata bor keluar dari lubang yang dibor. Ini akan membantu mencegah kemacetan.
9. Dengan bor kecepatan variabel, Anda tidak perlu membuat lubang tengah pada titik yang akan dibor. Gunakan kecepatan lambat untuk melubangi dan percepat dengan menekan pemacu lebih keras ketika lubang cukup dalam untuk dibor tanpa mata bor yang melompat-lompat keluar.

## Pengoperasian Bor Palu (gambar 6)

### DCD776

1. Ubah bantalan (c) ke simbol bor palu.
2. Pilih pengaturan kecepatan tinggi dengan menggeser pemilih ke belakang (menjauhi dari gagang gerak).  
**PENTING:** Gunakan hanya mata bor berujung karbit atau batuan.
3. Lakukan pengeboran dengan daya secukupnya pada palu agar tidak terlalu mental atau "timbul" dari mata bor. Terlalu banyak daya akan menyebabkan kecepatan pengeboran yang lebih lambat, pemanasan berlebihan, dan laju pengeboran yang lebih rendah.
4. Bor lurus, dengan tetap menjaga mata bor di ujung kanan pada benda kerja. Jangan menggunakan tekanan samping pada mata bor ketika pengeboran karena akan menyebabkan penyumbatan galur mata bor dan kecepatan pengeboran yang lebih lambat.
5. Ketika mengebor lubang yang dalam, jika kecepatan palu mulai menurun, tarik mata bor sebagian keluar dari lubang dengan alat yang masih berjalan untuk membantu membersihkan puing-puing dari lubang.

**CATATAN:** Aliran debu yang lancar dari lubang menunjukkan laju pengeboran yang tepat.

## PEMELIHARAAN

Alat listrik DEWALT Anda telah dirancang untuk penggunaan jangka panjang dengan pemeliharaan minimal. Kelanjutan hasil pengoperasian yang memuaskan tergantung pada pemeliharaan alat yang benar serta pembersihan yang teratur.



**PERINGATAN:** Untuk mengurangi risiko cedera diri yang berat, matikan alat dan lepas baterai sebelum melakukan penyesuaian apa pun atau melepaskan/memasang pelengkap atau aksesori. Alat yang mendadak menyala dapat mengakibatkan cedera.

Pengisi daya dan baterai tidak dapat diservis. Tidak ada komponen yang dapat diservis di dalamnya.



## Pelumas

Alat listrik Anda tidak membutuhkan pelumas tambahan.



## Pembersihan



**PERINGATAN:** Semprot ke luar kotoran dan debu pada bodi utama dengan udara kering sesering mungkin saat kotoran terlihat

mengendap di dalam dan di sekitar ventilasi udara. Gunakan pelindung mata yang sesuai dan masker debu yang sesuai bilamana mengerjakan prosedur ini.



**PERINGATAN:** Jangan gunakan pelarut atau bahan kimia keras lainnya untuk membersihkan bagian alat yang tidak terbuat dari logam. Zat-zat kimia tersebut dapat merapuhkan material komponen-komponen ini. Gunakan kain yang dilembapkan hanya dengan air dan sabun yang lembut. Jangan sampai bagian dalam alat kemasukan air; jangan pernah rendam komponen alat dalam cairan.

**PETUNJUK PEMBERSIHAN PENGISI DAYA**



**PERINGATAN:** Bahaya sengatan listrik. Lepaskan pengisi daya dari soket AC sebelum membersihkan. Kotoran dan gemuk dapat dihapus dari bagian luar pengisi daya menggunakan kain atau sikat non-logam yang lembut. Jangan gunakan air atau larutan pembersih apa pun.

**Aksesori Opsional**



**PERINGATAN:** Berhubung aksesori-aksesori lain, di luar yang disediakan oleh DEWALT, belum pernah diuji coba menggunakan produk ini, maka penggunaan aksesori semacam itu dengan alat ini dapat berbahaya. Untuk mengurangi risiko cedera, gunakan hanya aksesori DEWALT yang disarankan dengan produk ini.

Tanyakan kepada dealer Anda untuk informasi selengkapnya seputar aksesori yang sesuai.

**Melindungi Lingkungan**



Pengumpulan terpisah. Produk ini tidak boleh dibuang bersama limbah rumah tangga biasa.

Seandainya suatu hari Anda jumpai produk DEWALT Anda butuh diganti, atau tidak lagi berguna bagi Anda, jangan buang alat ini bersama limbah rumah tangga biasa. Pisahkan pengumpulan produk ini.



Pengumpulan produk dan kemasan bekas secara terpisah memungkinkan material untuk didaur ulang dan digunakan lagi. Penggunaan kembali bahan yang didaur ulang membantu mencegah pencemaran lingkungan dan mengurangi kebutuhan bahan baku.

Undang-undang setempat mungkin memfasilitasi pengumpulan produk-produk kelistrikan terpisah dari sampah rumah tangga, di tempat pembuangan sampah kota atau oleh pedagang ritel pada saat Anda membeli produk baru.

DEWALT menyediakan fasilitas pengumpulan dan pendaurulangan produk-produk DEWALT setelah mencapai akhir masa pakainya. Untuk memanfaatkan layanan ini, harap kembalikan produk Anda kepada agen reparasi resmi yang akan mengumpulkannya atas nama kami.

Anda dapat menemukan lokasi agen reparasi resmi terdekat Anda dengan menghubungi kantor DEWALT setempat di alamat yang tercantum pada buku petunjuk ini. Alternatif lainnya, Anda dapat melihat daftar agen reparasi DEWALT resmi dan detail lengkap layanan purna jual serta kontak kami yang tersedia di Internet, di: [www.2helpU.com](http://www.2helpU.com).



**Baterai yang Dapat Diisi Ulang**

Baterai bermasa pakai panjang ini harus diisi ulang daya bilamana gagal menghasilkan cukup daya untuk melakukan pekerjaan-pekerjaan yang sebelumnya dapat dikerjakan dengan mudah. Pada akhir masa pakai teknisnya, buang baterai dengan memperhitungkan perlindungan terhadap lingkungan:

- Kosongkan daya baterai, lalu lepaskan dari alat.
- Sel-sel Li-ION dapat didaur ulang. Bawa ke dealer Anda atau pusat pendaurulangan setempat. Baterai yang terkumpul akan didaur ulang atau dibuang dengan benar.

# สว่าน/ไขควง/สว่านเจาะกระแทกแบบไร้สาย 13 มม. (1/2") DCD734, DCD771, DCD776

## ขอแสดงความยินดี!

คุณได้เลือกใช้เครื่องมือจาก DeWALT ด้วยประสบการณ์หลายปีที่ผ่านมาในการพัฒนาผลิตภัณฑ์และนวัตกรรมใหม่ๆ ทำให้ DeWALT เป็นหนึ่งในเครื่องมือไฟฟ้าที่น่าเชื่อถือที่สุดสำหรับผู้ใช้เครื่องมือไฟฟ้าระดับมืออาชีพ

## ข้อมูลด้านเทคนิค

		DCD734	DCD771	DCD776
แรงดันไฟฟ้า	$V_{DC}$	14.4	18	18
ชนิด		1	1	1
ชนิดแบตเตอรี่		Li-ION	Li-ION	Li-ION
กำลังไฟออก	วัตต์	250	300	300
ความเร็วขณะไม่มีโหลด				
เกียร์ 1	นาที <sup>-1</sup>	0-400	0-450	0-450
เกียร์ 2	นาที <sup>-1</sup>	0-1300	0-1500	0-1500
อัตรากระแทก				
เกียร์ 1	นาที <sup>-1</sup>	-	-	0-7650
เกียร์ 2	นาที <sup>-1</sup>	-	-	0-25 500
แรงบิดสูงสุด (แข็ง/อ่อน)	นิวตัน-เมตร	38/22	42/24	42/24
ขนาดหัวจับดอกสว่าน	มม.	13	13	13
ความสามารถในการเจาะสูงสุด				
ไม้	มม.	30	30	30
โลหะ	มม.	10	13	13
ปูน	มม.	-	-	13
น้ำหนัก (ไม่รวมแบตเตอรี่)	กก.	1.2	1.3	1.34

แบตเตอรี่	DCB140	DCB141	DCB142	DCB143	DCB145
ชนิดแบตเตอรี่	Li-ION	Li-ION	Li-ION	Li-ION	Li-ION
แรงดันไฟฟ้า	$V_{DC}$	14.4	14.4	14.4	14.4
ความจุ	$A_h$	3.0	1.5	4.0	2.0
น้ำหนัก	kg	0.53	0.30	0.54	0.30
แบตเตอรี่	DCB185	DCB181	DCB183	DCB180	DCB182
ชนิดแบตเตอรี่	Li-ION	Li-ION	Li-ION	Li-ION	Li-ION
แรงดันไฟฟ้า	$V_{DC}$	18	18	18	18
ความจุ	$A_h$	1.3	1.5	2.0	3.0
น้ำหนัก	กก.	0.35	0.35	0.40	0.64

เครื่องชาร์จ	DCB107				
แรงดันไฟเมน	$V_{AC}$	230 V			
ชนิดแบตเตอรี่		Li-ION			
ระยะเวลาชาร์จโดยประมาณ	นาที	60	70	90	140
		(แบตเตอรี่ 1.3 Ah)	(แบตเตอรี่ 1.5 Ah)	(แบตเตอรี่ 2.0 Ah)	(แบตเตอรี่ 3.0 Ah)
					(แบตเตอรี่ 4.0 Ah)
น้ำหนัก	กก.	0.49			

## คำจำกัดความ: ข้อแนะนำด้านความปลอดภัย

คำจำกัดความด้านล่างอธิบายถึงระดับความรุนแรงของคำแต่ละคำที่ใช้เรียกสัญลักษณ์ต่างๆ โปรดอ่านคู่มือและใส่ใจกับสัญลักษณ์เหล่านี้



**อันตราย:** หมายถึงสถานการณ์ที่ก่อให้เกิดอันตรายได้อย่างฉับพลัน ซึ่งหากไม่ระวังจะทำให้เสียชีวิตหรือบาดเจ็บสาหัสได้



**คำเตือน:** หมายถึงสถานการณ์ที่มีแนวโน้มว่าจะก่อให้เกิดอันตราย ซึ่งหากไม่ระวังสามารถทำให้เกิดอันตรายถึงชีวิตหรือบาดเจ็บสาหัสได้



**ข้อควรระวัง:** หมายถึงสถานการณ์ที่มีแนวโน้มว่าจะก่อให้เกิดอันตราย ซึ่งหากไม่ระวังอาจทำให้ได้รับบาดเจ็บเล็กน้อยถึงปานกลาง

**ข้อสังเกต:** หมายถึงการปฏิบัติที่ไม่เกี่ยวข้องกับการบาดเจ็บส่วนบุคคล ซึ่งหากไม่ระวังอาจทำให้ทรัพย์สินเสียหาย



แสดงถึงความเสี่ยงจากการถูกไฟฟ้าช็อต



แสดงถึงความเสี่ยงจากการเกิดเพลิงไหม้



**คำเตือน:** เพื่อลดความเสี่ยงจากการบาดเจ็บ โปรดอ่านคู่มือการใช้งานเล่มนี้

## คำเตือนเพื่อความปลอดภัยทั่วไป สำหรับการใช้อุปกรณ์ไฟฟ้า



**คำเตือน!** โปรดอ่านคำเตือนและข้อปฏิบัติเพื่อความปลอดภัยทั้งหมด การไม่ปฏิบัติตามคำเตือนและข้อปฏิบัติเหล่านี้อาจทำให้เกิดไฟฟ้าช็อต เกิดอัคคีภัย และหรือบาดเจ็บสาหัสได้



โปรดเก็บรักษาคำเตือนและข้อปฏิบัติทั้งหมดไว้เพื่อใช้อ้างอิงในภายหลัง

คำว่า “เครื่องมือไฟฟ้า” ในคำเตือน หมายถึง เครื่องมือไฟฟ้า (แบบมีสาย) ที่ทำงานผ่านแหล่งจ่ายไฟหลัก หรือเครื่องมือไฟฟ้า (แบบไร้สาย) ที่ทำงานผ่านแบตเตอรี่

## 1) ความปลอดภัยในบริเวณที่ทำงาน

- รักษาความสะอาดและจัดให้มีแสงสว่างเพียงพอในบริเวณที่ทำงาน บริเวณที่มีตึกหรือมีช่องว่างระกระระอาจทำให้เกิดอุบัติเหตุได้
- ห้ามใช้เครื่องมือไฟฟ้าในบริเวณที่อาจเกิดการระเบิด เช่น ในสถานที่ที่มีของเหลว แก๊ส หรือฝุ่นละอองที่มีคุณสมบัติไวไฟ เครื่องมือไฟฟ้าจะทำให้เกิดประกายไฟที่อาจทำให้เกิดละอองไฟหรือเปลวไฟขึ้นได้
- ระวังไม่ให้เด็กเล็กและคนเดินผ่านไปมาเข้าใกล้ในขณะที่ใช้งานเครื่องมือไฟฟ้า สิ่งรบกวนอาจทำให้คุณเสียสมาธิได้

## 2) ความปลอดภัยทางไฟฟ้า

- ปลั๊กไฟของเครื่องต้องเป็นชนิดเดียวกับเต้ารับ ห้ามดัดแปลงปลั๊กไม่ว่าด้วยวิธีใด ห้ามใช้ปลั๊กอะแดปเตอร์ใดๆ กับเครื่องมือไฟฟ้าที่ต่อสายดิน (ลงกราวด์) ปลั๊กที่ไม่มีกราดดแปลงและเต้ารับชนิดเดียวกันจะช่วยลดความเสี่ยงจากการถูกไฟฟ้าช็อต
- หลีกเลี่ยงการสัมผัสพื้นผิวที่ต่อสายดินหรือลงกราวด์ เช่น ท่อ หม้อน้ำ เตาหุงต้ม และตู้เย็น มีความเสี่ยงเพิ่มขึ้นที่จะถูกไฟฟ้าช็อตหากร่างกายของคุณเป็นสื่อเชื่อมต่อกับดินหรือลงกราวด์
- อย่าให้เครื่องมือไฟฟ้าถูกฝนหรืออยู่ในสภาพที่เปียกชื้น น้ำที่เข้าเครื่องมือไฟฟ้าจะทำให้มีความเสี่ยงในการถูกไฟฟ้าช็อตเพิ่มขึ้น
- ห้ามใช้สายไฟผิดวัตถุประสงค์ ห้ามใช้สายไฟเพื่อการหิ้วดึง หรือถอดปลั๊กเครื่องมือไฟฟ้า เก็บสายไฟให้พ้นจากความร้อน น้ำมัน ของมีคม หรือ ชิ้นส่วนที่กำลังเคลื่อนที่ สายไฟที่ชำรุดหรือพันกันเป็นการเพิ่มความเสี่ยงจากการถูกไฟฟ้าช็อต
- เมื่อใช้เครื่องมือไฟฟ้านอกอาคาร ให้ใช้สายต่อพ่วงที่เหมาะสมสำหรับการใช้งานนอกอาคาร ใช้สายไฟที่เหมาะสมกับการใช้งานนอกอาคารเพื่อลดความเสี่ยงต่อการเกิดไฟฟ้าช็อต
- หากไม่สามารถหลีกเลี่ยงการใช้เครื่องมือไฟฟ้าในบริเวณที่ชื้นแฉะได้ ให้ใช้อุปกรณ์ป้องกันไฟฟ้าสะสม (RCD) ที่จัดไว้ให้ การใช้ RCD จะช่วยลดความเสี่ยงจากการถูกไฟฟ้าช็อต

## 3) ความปลอดภัยส่วนบุคคล

- ตื่นตัวและมีสมาธิกับสิ่งที่คุณกำลังทำ รวมทั้งใช้สามัญสำนึก ในขณะที่กำลังใช้งานเครื่องมือไฟฟ้า ห้ามใช้เครื่องมือไฟฟ้าในขณะที่คุณกำลังเหนื่อยหรือได้รับอิทธิพลจากยา แอลกอฮอล์ หรือการรักษายาบางอย่าง การขาดความระมัดระวังในการใช้เครื่องมือไฟฟ้าแม้ชั่วขณะหนึ่งอาจทำให้บาดเจ็บสาหัสได้
- ใช้อุปกรณ์คุ้มครองความปลอดภัยส่วนบุคคล สวมอุปกรณ์ป้องกันดวงตาเสมอ อุปกรณ์ป้องกัน เช่น หน้ากากกันฝุ่น รองเท้านิรภัยกันลื่น หมวกนิรภัย หรืออุปกรณ์ป้องกันเสียงดังที่ขึ้นในสภาวะที่เหมาะสมจะช่วยลดอาการบาดเจ็บทางร่างกาย
- บล็อกลูกเปิดเครื่องเปิดทำงานโดยอัตโนมัติ สวิตช์ต้องอยู่ในตำแหน่งปิดก่อนที่จะเสียบปลั๊กเครื่องเข้ากับแหล่งจ่ายไฟ และ/หรือแบตเตอรี่ หรือก่อนยกหรือหัวเครื่องมือการบางเครื่องมือไฟฟ้าในขณะที่นิ้วอยู่ที่สวิตช์ หรือใช้เครื่องมือไฟฟ้าที่สวิตช์เปิดอยู่ อาจทำให้เกิดอุบัติเหตุได้
- ถอดกุญแจปรับแต่งหรือประแจออกก่อนเปิดสวิตช์เครื่องมือไฟฟ้า ประแจหรือกุญแจที่เสียบค้างอยู่ในชิ้นส่วนที่หมุนได้ของเครื่องมือไฟฟ้าอาจทำให้ได้รับบาดเจ็บได้

- จ) ห้ามยืนแช่เท้าขณะใช้เครื่อง ควรวินให้เท้าที่เหมาะสม และสวมชุดตลอดเวลา เพื่อช่วยในการควบคุมเครื่องมือไฟฟ้า ได้ดียิ่งขึ้นในสถานการณ์ที่ไม่คาดคิด
- ฉ) แต่งกายให้เหมาะสม ห้ามสวมเสื้อผ้าหลวมหรือใส่เครื่องประดับ รวบผม ชายเสื้อ และถุงมือให้ห่างจากชิ้นส่วนที่กำลังหมุน เสื้อผ้าที่หลวมหรือยาวรุ่มร่าม เครื่องประดับ หรือผมที่ยาวอาจเข้าไปพันกับชิ้นส่วนที่กำลังหมุน
- ช) หากมีอุปกรณ์สำหรับดูดและเก็บฝุ่น ต้องตรวจสอบให้แน่ใจว่าได้เชื่อมต่อและใช้งานอุปกรณ์นั้นอย่างเหมาะสม การใช้อุปกรณ์เก็บฝุ่นจะช่วยลดอันตรายที่เกี่ยวข้องกับฝุ่นได้
- 4) การใช้และการดูแลรักษาเครื่องมือไฟฟ้า
- ก) ห้ามเดินใช้เครื่องมือไฟฟ้า เลือกใช้เครื่องมือไฟฟ้าที่ถูกต้องตรงกับลักษณะการใช้งานของคุณ เครื่องมือไฟฟ้า ที่ถูกต้องย่อมทำงานได้ดีกว่าและปลอดภัยกว่า เมื่อใช้งานตามพิกัดที่เครื่องมือได้รับการออกแบบมา
- ข) ห้ามใช้เครื่องมือไฟฟ้าถ้าสวิตช์เปิดปิดเครื่องไม่ทำงาน เครื่องมือไฟฟ้าที่ไม่สามารถควบคุมผ่านสวิตช์ได้ มีอันตราย และต้องส่งซ่อม
- ค) ถอดปลั๊กของเครื่องมือไฟฟ้าออกจากแหล่งจ่ายไฟ และ/หรือ แบตเตอรี่ก่อนทำการปรับแต่ง เปลี่ยนอุปกรณ์เสริม หรือจัดเก็บ มาตรการเพื่อความปลอดภัยซึ่งป้องกันนี้จะช่วยลดความเสี่ยงในการเปิดเครื่องให้ทำงานโดยไม่ตั้งใจ
- ง) เก็บเครื่องมือไฟฟ้าที่ไม่ได้ใช้งานไว้ในหีบน้อยเด็ก และไมอนุญาตให้บุคคลที่ไม่คุ้นเคยกับเครื่องมือไฟฟ้าหรือข้อปฏิบัติเหล่านี้เป็นผู้ใช้เครื่องมือ เครื่องมือไฟฟ้าจะเป็นอันตรายหากอยู่ในมือผู้ใช้ที่ไม่มีความชำนาญ
- จ) บำรุงรักษาเครื่องมือไฟฟ้า ตรวจสอบว่าชิ้นส่วนที่เคลื่อนที่ได้มีการวางไม่ตรงแนวหรือติดขัดหรือไม่ มีชิ้นส่วนที่แตกหัก และสภาพอื่นใดที่อาจส่งผลต่อการทำงานของเครื่องมือไฟฟ้าหรือไม่ หากชำรุดเสียหาย ให้นำเครื่องมือไปส่งซ่อมก่อนนำมาใช้ อุบัติเหตุจำนวนมากเกิดจากการดูแลรักษาเครื่องมือไฟฟ้าไม่ดีพอ
- ฉ) เครื่องมือตัดต้องคมและสะอาดอยู่เสมอ เครื่องมือตัดที่ได้รับการดูแลรักษาอย่างถูกต้องและมีขอบตัดคม จะมีปัญหาตัดฉีกฉีก และควบคุมได้ง่ายกว่า
- ช) ใช้เครื่องมือไฟฟ้า อุปกรณ์เสริม และดอกสว่านหรือใบมีดของเครื่องมือ เป็นต้น ให้ตรงตามข้อปฏิบัติเหล่านี้ โดยพิจารณาถึงสภาพการทำงานและงานที่ทำเป็นสำคัญ การใช้เครื่องมือไฟฟ้าทำงานอื่นนอกเหนือจากที่กำหนดไว้ อาจทำให้เกิดอันตรายได้
- 5) การใช้และการดูแลรักษาแบตเตอรี่
- ก) ชาร์จแบตเตอรี่ด้วยเครื่องชาร์จที่ผู้ผลิตแนะนำเท่านั้น เครื่องชาร์จที่เหมาะสมกับก้อนแบตเตอรี่แบบหนึ่งอาจทำให้เกิดไฟไหม้ได้ถ้านำมาใช้ร่วมกับก้อนแบตเตอรี่อีกแบบหนึ่ง
- ข) ใช้เครื่องมือไฟฟ้าเฉพาะกับก้อนแบตเตอรี่ที่กำหนดให้ โดยเฉพาะเท่านั้น การใช้อีกแบบอื่น อาจทำให้เสี่ยงต่อการบาดเจ็บและเกิดไฟไหม้ได้
- ค) เมื่อไม่ได้ใช้ก้อนแบตเตอรี่ ให้เก็บออกห่างจากวัตถุอื่น ๆ ที่เป็นโลหะ เช่น คลิปหนีบกระดาษ เหรียญ กุญแจ ตะปู สกรู หรือวัตถุขนาดเล็กอื่น ๆ ที่ทำจากโลหะที่อาจทำให้เกิดการเชื่อมต่อนระหว่างขั้วของแบตเตอรี่ได้ การลัดวงจรบริเวณขั้วแบตเตอรี่อาจทำให้เกิดรอยไหม้หรือไฟไหม้ได้
- ง) เมื่ออยู่ภายใต้สภาวะที่ไม่เหมาะสม อาจมีของเหลวไหลออกจากแบตเตอรี่ ให้หลีกเลี่ยงการสัมผัสกับของเหลวนี้ หากบังเอิญสัมผัสโดยไม่ตั้งใจ ให้ล้างด้วยน้ำปริมาณมาก หากของเหลวกระเด็นเข้าตา ควรรีบไปพบแพทย์ ของเหลวที่ออกมาจากแบตเตอรี่อาจทำให้เกิดอาการระคายเคืองหรือรอยไหม้ได้
- 6) การบริการ
- ก) ให้ช่างซ่อมที่มีความเชี่ยวชาญเป็นผู้ซ่อมเครื่องมือ และใช้อะไหล่แท้เท่านั้น ซึ่งจะช่วยให้มั่นใจได้ว่าเครื่องมือไฟฟ้ายังมีความปลอดภัยอยู่
- กฎเกณฑ์ด้านความปลอดภัยเฉพาะเพิ่มเติมสำหรับสว่าน/ไขควง/สว่านเจาะกระแทก
- สวมใส่อุปกรณ์ป้องกันเสียงดังเมื่อทำงานเจาะกระแทก การเผชิญกับเสียงดังมาก ๆ อาจทำให้สูญเสียความสามารถในการได้ยิน
  - ใช้มือจับเสริมหากให้มาพร้อมกับเครื่องการสูญเสียการควบคุม เครื่องอาจทำให้ได้รับบาดเจ็บได้
  - จับเครื่องมือไฟฟ้าตรงพื้นผิวส่วนที่ใช้จับซึ่งมีฉนวนป้องกันเท่านั้น เมื่อต้องใช้งานเครื่องมือในบริเวณที่อุปกรณ์เสริมสำหรับการตัดอาจสัมผัสถูกสายไฟที่ซ่อนอยู่ได้ อุปกรณ์เสริมสำหรับการตัดที่สัมผัสถูกสายไฟ "ที่มีไฟฟ้า" อาจทำให้ส่วนของโลหะที่ไหลออกมา "มีไฟฟ้า" และทำให้ผู้ใช้เครื่องมือถูกไฟฟ้าช็อตได้
  - ใช้แคลมป์ยึดหรือวิธีอื่น ๆ ที่ได้ผลเพื่อยึดและรองรับชิ้นงานบนแท่นที่มั่นคง การใช้มือจับหรือให้ชิ้นงานพิงกับลำตัวจะไม่นับเนื่องเพียงพอและอาจทำให้สูญเสียการควบคุมได้
  - สวมแว่นตานิภัยหรืออุปกรณ์ป้องกันดวงตาแบบอื่น ๆ การเจาะและการเจาะกระแทกจะทำให้เศษชิ้นงานปลิวได้ เศษชิ้นงานที่ปลิวออกมาอาจทำลายดวงตาอย่างถาวร

- อุปกรณ์เสริมและเครื่องมืออาจร้อนในขณะที่ใช้งาน ให้สวมถุงมือขณะจับถือสิ่งเหล่านี้ ถ้าต้องทำงานที่ทำให้เกิดความร้อน เช่น การเจาะและการเจาะกระแทกโลหะ
- อย่าใช้งานเครื่องมือที่ต่อห้องเป็นเวลานาน แรงสั่นสะเทือนที่เกิดจากการเจาะกระแทก อาจทำให้เกิดอันตรายต่อมือและแขนของคุณ ใช้ถุงมือเพื่อดูดซับแรงสั่นสะเทือนบางส่วน และจำกัดแรงสั่นสะเทือนโดยหยุดเครื่องเป็นระยะ ๆ
- ช่อระบายอากาศมักครอบบนชิ้นส่วนที่มีการเคลื่อนที่ และควรหลีกเลี่ยง เสื้อผ้าที่หลวม เครื่องประดับ หรือผมที่ยาวอาจเข้าไปพันกับชิ้นส่วนที่มีการเคลื่อนที่

## ความเสี่ยงอื่น ๆ ที่ยังมีอยู่

การใช้งานส่วนไฟฟ้าอาจเป็นสาเหตุของความเสี่ยงดังต่อไปนี้:

- การบาดเจ็บจากการสัมผัสชิ้นส่วนของเครื่องมือที่กำลังหมุนหรือร้อน

แม้จะปฏิบัติตามข้อกำหนดด้านความปลอดภัยที่เกี่ยวข้องและใช้อุปกรณ์นิรภัยแล้วก็ตาม แต่ก็ไม่สามารถหลีกเลี่ยงความเสี่ยงบางอย่างได้ ความเสี่ยงเหล่านั้นได้แก่:

- ความบกพร่องในการได้ยินเสียง
- ความเสี่ยงของการหนีบถูกนิ้วในขณะที่เปลี่ยนอุปกรณ์เสริม
- อันตรายต่อสุขภาพที่เกิดจากการสูดดมฝุ่นที่เกิดขึ้นในขณะที่ทำงานกับไม้
- ความเสี่ยงที่จะได้รับบาดเจ็บจากเศษชิ้นงานที่ปลิว
- ความเสี่ยงที่จะได้รับบาดเจ็บเนื่องจากการใช้งานเป็นเวลานาน

## สัญลักษณ์บนเครื่องมือ

รูปภาพต่อไปนี้จะปรากฏบนเครื่องมือ:



โปรดอ่านคู่มือแนะนำการใช้งาน

### ตำแหน่งของรหัสวันที่ (รูป 1)

รหัสวันที่ (j) ซึ่งแสดงปีที่ผลิตเอาไว้ด้วย จะพิมพ์อยู่บนตัวเครื่องบริเวณที่เป็นจุดเชื่อมต่อระหว่างเครื่องมือกับแบตเตอรี่ ตัวอย่างเช่น:

2014 XX XX

ปีที่ผลิต

## คำแนะนำเพื่อความปลอดภัยที่สำคัญสำหรับเครื่องชาร์จแบตเตอรี่ทุกชนิด

เก็บรักษาคำแนะนำเหล่านี้ไว้: คู่มือนี้ประกอบด้วยคำแนะนำความปลอดภัยและการใช้งานที่สำคัญสำหรับเครื่องชาร์จแบตเตอรี่ DCB107

- ก่อนใช้งานเครื่องชาร์จ โปรดอ่านคำแนะนำและสัญลักษณ์เตือน

ทั้งหมดทั้งบนเครื่องชาร์จ แบตเตอรี่ และผลิตภัณฑ์ที่ใช้แบตเตอรี่



**คำเตือน:** อันตรายจากการถูกไฟฟ้าช็อต อย่าปล่อยให้ของเหลวใดๆ เข้าไปในเครื่องชาร์จ เพราะอาจทำให้เกิดไฟฟ้าช็อต



**ข้อควรระวัง:** อันตรายจากไฟไหม้ เพื่อลดความเสี่ยงของการเกิดการบดเจ็บบรรเทาใช้แบตเตอรี่แบบชาร์จซ้ำได้ของ DeWALT เท่านั้น แบตเตอรี่ชนิดอื่นอาจทำให้เกิดความร้อนสูงและระเบิด ส่งผลให้ได้รับบาดเจ็บและทรัพย์สินเสียหายได้



**ข้อควรระวัง:** ควรกำกับดูแลไม่ให้เกิดเลนเครื่องมือ ข้อสังเกต: ในบางสถานการณ์ ระหว่างที่เครื่องชาร์จเสียบปลั๊กอยู่ อาจมีวัตถุแปลกปลอมเข้าไปภายในเครื่องชาร์จและทำให้ตัวชาร์จไฟลัดวงจรได้ อย่าให้มีวัตถุแปลกปลอมที่มีคุณสมบัตินำไฟฟ้า เช่น ฝอยเหล็ก อะลูมิเนียมพอยล์ หรือการสะสมตัวของอนุภาคโลหะอยู่ในช่องใส่แบตเตอรี่ของเครื่องชาร์จ และถอดปลั๊กเครื่องชาร์จเสมอเมื่อไม่มีแบตเตอรี่อยู่ภายในช่องใส่ รวมทั้งถอดปลั๊กเครื่องชาร์จทุกครั้งก่อนที่ทำความสะอาด

- อย่าชาร์จแบตเตอรี่ด้วยเครื่องชาร์จเครื่องอื่น ๆ นอกเหนือจากเครื่องชาร์จที่ระบุในคู่มือเล่มนี้โดยเด็ดขาด เครื่องชาร์จและก้อนแบตเตอรี่ได้รับการออกแบบมาให้ใช้งานร่วมกันโดยเฉพาะ
- เครื่องชาร์จที่ไม่ได้ออกแบบมาเพื่อการใช้งานใดๆ นอกจากเครื่องชาร์จแบบชาร์จซ้ำได้ของ DEWALT การนำไปใช้ในงานอื่นอาจเสี่ยงต่อการเกิดไฟไหม้ ไฟฟ้าช็อต หรืออันตรายจากไฟฟ้าจนถึงแก่ชีวิตได้
- อย่าให้เครื่องชาร์จถูกฝนหรือหิมะ
- เมื่อจะถอดปลั๊กเครื่องชาร์จให้ดึงที่ปลั๊กไม่ใช่ที่สายไฟ วิธีนี้จะช่วยลดความเสี่ยงที่ปลั๊กและสายไฟจะชำรุดเสียหายได้
- ตรวจสอบให้แน่ใจว่าสายไฟไม่อยู่ในตำแหน่งที่จะถูกเหยียบตะ สะดุด หรือกรณีอื่นใดที่อาจก่อให้เกิดความเสียหายหรือความเครียดในสายไฟได้
- ห้ามใช้สายต่อพ่วง เว้นแต่มีคำแนะนำเป็นอย่างหลีกเลี่ยงไม่ได้ การใช้สายต่อพ่วงที่ไม่เหมาะสมอาจเสี่ยงต่อการเกิดไฟไหม้ ไฟฟ้าช็อต หรืออันตรายจากไฟฟ้าจนถึงแก่ชีวิตได้
- ทุกครั้งที่ใช้งานเครื่องชาร์จนอกอาคาร ให้เตรียมสถานที่แห้งและใช้งานสายต่อพ่วงที่เหมาะสมสำหรับการใช้งานนอกอาคารเสมอ ใช้สายไฟที่เหมาะสมสำหรับใช้นอกอาคารจะช่วยลดความเสี่ยงต่อการเกิดไฟฟ้าช็อต
- อย่าปิดกั้นช่อระบายอากาศของเครื่องชาร์จ ช่อระบายอากาศจะอยู่ที่บริเวณด้านบนและด้านข้างของเครื่องชาร์จ วางเครื่องชาร์จในตำแหน่งที่ห่างจากแหล่งกำเนิดความร้อน

- ห้ามใช้งานเครื่องชาร์จที่มีสายไฟหรือปลั๊กชำรุดเสียหาย — ให้เปลี่ยนใหม่ทันที
- ห้ามใช้งานเครื่องชาร์จที่ถูกกระแทกอย่างรุนแรง ตก หรือได้รับความเสียหายรูปแบบใด ๆ ก็ตามให้หาเครื่องชาร์จดังกล่าวไปยังศูนย์บริการที่ได้รับอนุญาต
- ห้ามถอดชิ้นส่วนเครื่องชาร์จเอง โปรดนำเครื่องชาร์จไปยังศูนย์บริการที่ได้รับอนุญาตเมื่อจำเป็นต้องซ่อมแซมหรือรับบริการ การประกอบเครื่องชาร์จกลับดั้งเดิมอย่างไม่ถูกต้องอาจเสี่ยงต่อการถูกไฟฟ้าช็อต หรือได้รับอันตรายจากไฟฟ้าจนถึงแก่ชีวิต หรือเกิดไฟไหม้ได้
- ในกรณีที่มีสายไฟของตัวเครื่องชำรุดเสียหาย สายไฟดังกล่าวต้องได้รับการเปลี่ยนโดยผู้ผลิต หรือตัวแทนศูนย์บริการของผู้ผลิต หรือบุคคลที่มีคุณสมบัติเทียบเท่า เพื่อหลีกเลี่ยงอันตรายที่อาจเกิดขึ้นได้
- ถอดปลั๊กของเครื่องชาร์จออกจากเต้ารับทุกครั้งก่อนทำความสะอาด การทำเช่นนี้จะช่วยลดความเสี่ยงจากการถูกไฟฟ้าช็อต การถอดก่อนแบตเตอรี่ออกจะไม่ทำให้ความเสี่ยงนี้ลดลง
- ห้ามเชื่อมต่อเครื่องชาร์จ 2 เครื่องเข้าด้วยกัน
- เครื่องชาร์จนี้ได้รับการออกแบบมาเพื่อใช้กับแรงดันไฟฟ้าบ้าน 230 V ทำไป ห้ามนำเครื่องชาร์จไปใช้กับแรงดันไฟฟ้าอื่น ๆ ทั้งนี้ไม่รวมถึงเครื่องชาร์จสำหรับใช้ในรถยนต์

เก็บรักษาคำแนะนำเหล่านี้ไว้

## เครื่องชาร์จ

เครื่องชาร์จ DCB107 รองรับแบตเตอรี่ Li-ION 10.8 V, 14.4 V และ 18 V (แบตเตอรี่รุ่น DCB121, DCB123, DCB125, DCB127, DCB140, DCB141, DCB142, DCB144, DCB145, DCB180, DCB181, DCB182, DCB183, DCB184, และ DCB185)

เครื่องชาร์จนี้ถูกออกแบบมาเพื่อให้ง่ายต่อการใช้งาน ดังนั้นจึงไม่มีความจำเป็นที่จะต้องปรับแต่งใด ๆ เมื่อชาร์จแบตเตอรี่ต่างรุ่นกัน

## ขั้นตอนการชาร์จ (รูป 2)



- เสียบปลั๊กเครื่องชาร์จเข้ากับเต้ารับซึ่งจ่ายไฟฟ้าแรงดัน 220-240V ที่เหมาะสมก่อนเสียบแบตเตอรี่
- ใส่แบตเตอรี่ (g) ลงในเครื่องชาร์จ ตรวจสอบให้แน่ใจว่าแบตเตอรี่เข้าไปอยู่ในเครื่องชาร์จสนิทแล้ว ไฟสีแดง (กำลังชาร์จ) จะกะพริบต่อเนื่องเพื่อแสดงว่ากระบวนการชาร์จเริ่มต้นแล้ว
- ถ้าการชาร์จเสร็จสิ้นไฟสีแดงนี้จะติดสว่างต่อเนื่อง

แบตเตอรี่จะได้รับการประจุไฟจนเต็ม และสามารถนำไปใช้ได้เลย หรืออาจปล่อยให้เครื่องชาร์จก็ได้

หมายเหตุ: เพื่อให้แบตเตอรี่ Li-ION มีประสิทธิภาพเต็มที่และอายุการใช้งานสูงสุด ให้ชาร์จแบตเตอรี่ให้เต็มก่อนใช้งานครั้งแรก

## กระบวนการชาร์จ

โปรดดูสถานะการชาร์จของแบตเตอรี่จากตารางด้านล่าง

สถานะการชาร์จ—DCB107	
	กำลังชาร์จ
	ชาร์จเต็มแล้ว
	หยุดพักเนื่องจากแบตเตอรี่ร้อน/เย็น

## การหยุดพักเนื่องจากแบตเตอรี่ร้อน/เย็น (DCB107)

เครื่องชาร์จ DCB107 สามารถหยุดพักเมื่อแบตเตอรี่ร้อน/เย็นได้ เมื่อเครื่องชาร์จตรวจพบว่าแบตเตอรี่ร้อน เครื่องจะหยุดพักการชาร์จโดยอัตโนมัติจนกว่าแบตเตอรี่จะเย็นลง เมื่อเครื่องชาร์จตรวจพบว่าแบตเตอรี่เย็น เครื่องจะหยุดพักการชาร์จโดยอัตโนมัติจนกว่าแบตเตอรี่จะอุ่น

ไฟสีแดงจะยังคงกะพริบต่อไป แต่ไฟเตือนสีเหลืองจะติดสว่างระหว่างการทำงานในช่วงนี้ เมื่อแบตเตอรี่เย็นลงแล้ว ไฟสีเหลืองจะดับ และเครื่องชาร์จจะเริ่มชาร์จต่อ

เครื่องมือ XR Li-ION ได้รับการออกแบบให้มาพร้อมทั้งระบบป้องกันอิเล็กทรอนิกส์ (Electronic Protection System) ซึ่งจะปกป้องแบตเตอรี่จากการโอเวอร์โหลด ความร้อนสูงเกิน หรือเกิดการคายประจุจนเกือบหมด

เครื่องมือจะปิดโดยอัตโนมัติเมื่อระบบป้องกันอิเล็กทรอนิกส์ทำงาน หากเกิดเหตุการณ์ดังกล่าวขึ้นให้นำแบตเตอรี่ Li-ION ไปวางชาร์จที่เครื่องชาร์จจนกระทั่งเต็ม

## คำแนะนำเพื่อความปลอดภัยที่สำคัญสำหรับแบตเตอรี่ทุกชนิด

เมื่อจะสั่งซื้อแบตเตอรี่รุ่นใหม่ ให้ระบุรหัสแบตเตอรี่และแรงดันไฟฟ้า

แบตเตอรี่ใหม่ที่เพิ่งแกะจากกล่องยังไม่ได้รับการชาร์จไฟให้เต็ม ก่อนใช้งานแบตเตอรี่และเครื่องชาร์จให้อ่านคำแนะนำเพื่อความปลอดภัยด้านล่างและปฏิบัติตามขั้นตอนการชาร์จที่ระบุไว้

### อ่านคำแนะนำทั้งหมด

- ห้ามชาร์จหรือใช้งานแบตเตอรี่ในบริเวณที่อาจเกิดการระเบิด เช่น ในสถานที่ที่มีของเหลว แก๊ส หรือฝุ่นละอองที่มีคุณสมบัติไวไฟ การใส่และถอดแบตเตอรี่ออกจากเครื่องชาร์จอาจเป็นการจู่ระเบิดฝุ่นหรือไอระเหยดังกล่าวได้
- ห้ามฝืนใส่แบตเตอรี่ลงในเครื่องชาร์จ ห้ามดัดแปลงก่อนแบตเตอรี่ด้วยวิธีการใด ๆ เพื่อให้สามารถใส่ลงในเครื่อง



ชาร์จที่ไม่รองรับแบตเตอรี่นั้น เนื่องจากก้อนแบตเตอรี่อาจจะเบียดขึ้น เป็นเหตุให้บาดเจ็บสาหัสได้

- ชาร์จแบตเตอรี่ในเครื่องชาร์จของ DEWALT ที่กำหนดเท่านั้น
- ห้ามสาดหรือจุ่มลงในน้ำหรือของเหลวอื่นใดโดยเด็ดขาด
- ห้ามเก็บหรือใช้งานเครื่องมือและแบตเตอรี่ในสถานที่ซึ่งอุณหภูมิอาจสูงถึงหรือสูงเกินกว่า 40° C (105° F) (เช่น ในโรงเรือนกลางแจ้งหรืออาคารโลหะในช่วงฤดูร้อน)
- เพื่อผลลัพธ์ที่ดีที่สุด ให้ตรวจสอบให้แน่ใจว่าได้ชาร์จแบตเตอรี่เต็มแล้วก่อนใช้งาน



**คำเตือน:** ห้ามพยายามแกะตัวแบตเตอรี่ในทุกกรณี หากตัวก้อนแบตเตอรี่มีรอยแตกหรือเสียหาย ห้ามนำใส่เข้าไปในเครื่องชาร์จโดยเด็ดขาด ห้ามทุบ ท้าตก หรือทำให้แบตเตอรี่ชำรุดเสียหาย ห้ามใช้งานแบตเตอรี่และเครื่องชาร์จที่ถูกกระแทกอย่างรุนแรง เคยตก ถูกทับ หรือได้รับความเสียหายในรูปแบบใดๆ (เช่น ถูกตะปูตอกทะลุ ถูกค้อนทุบ ถูกเหยียบ) เพราะอาจทำให้เกิดไฟฟ้าช็อตหรือเกิดอันตรายจากไฟฟ้าจนถึงแก่ชีวิตได้ ควรส่งแบตเตอรี่ที่ชำรุดเสียหายคืนให้ศูนย์บริการเพื่อนำไปรีไซเคิล



**ข้อควรระวัง:** เมื่อไม่ใช้งาน ให้วางเครื่องมือตะแคงไว้บนพื้นผิวที่มั่นคงที่จะไม่ทำให้เกิดอันตรายจากการสะดุดหรือร่วงหล่น อุปกรณ์บางอย่างที่มีแบตเตอรี่ก้อนใหญ่อาจจะสามารถวางตั้งบนแบตเตอรี่ได้ แต่ก็อาจถูกชนล้มได้ง่ายเช่นกัน

**คำแนะนำเพื่อความปลอดภัยเฉพาะสำหรับแบตเตอรี่ลิเธียมไอออน (Li-Ion)**

- ห้ามเผาแบตเตอรี่แม้ว่าแบตเตอรี่นั้นจะได้รับความเสียหายอย่างร้ายแรงหรือใช้งานจนหมดแล้วก็ตาม แบตเตอรี่สามารถระเบิดได้ในเปลวไฟ ไอและสารพิษจะเกิดขึ้นเมื่อแบตเตอรี่ลิเธียมไอออนถูกเผา
- หากสารภายในแบตเตอรี่สัมผัสกับผิวหนังให้รีบล้างออกด้วยสบู่อ่อนและน้ำทันที หากของเหลวภายในแบตเตอรี่เข้าตา ให้ล้างตาในน้ำไหลผ่านเป็นเวลา 15 นาทีหรือจนไม่รู้สึกระคายเคืองอีก หากจำเป็นต้องไปพบแพทย์ สารอิเล็กทรอนิกส์ของแบตเตอรี่เป็นส่วนผสมของสารละลายคาร์บอนเนตอินทรีย์และเกลือลิเธียม
- สารภายในแบตเตอรี่ที่ถูกเปิดออกอาจทำให้ระบบหายใจระคายเคืองได้ ให้รีบไปยังสถานที่ที่มีอากาศถ่ายเท หากอาคาร

ผิดปกติไม่หายไป ให้รีบพบแพทย์



**คำเตือน:** อันตรายจากไฟไหม้ ของเหลวในแบตเตอรี่อาจติดไฟได้หากสัมผัสกับประกายไฟหรือเปลวไฟ

**แบตเตอรี่**

**ชนิดแบตเตอรี่**

DCD734 ทำงานด้วยแบตเตอรี่ 14.4 V

DCD771 และ DCD776 ทำงานด้วยแบตเตอรี่ 18V

อาจนำแบตเตอรี่ DCB140, DCB142, DCB143, DCB144, DCB145, DCB180, DCB181, DCB182, DCB183, DCB184 หรือ DCB185 มาใช้ได้ โดยอ้างอิงจาก “ข้อมูลทางเทคนิค” เพิ่มเติม

**คำแนะนำการเก็บรักษา**

1. สถานที่เก็บรักษาอุปกรณ์ที่เหมาะสมที่สุดคือสถานที่ซึ่งแห้งและเย็น ไม่ได้รับแสงอาทิตย์โดยตรง และอุณหภูมิไม่ร้อนหรือเย็นมากเกินไป เพื่อให้ประสิทธิภาพและอายุการใช้งานของแบตเตอรี่ยาวนานสูงสุด ควรเก็บรักษาแบตเตอรี่ในอุณหภูมิห้องเมื่อไม่ใช้งาน
2. กรณีเก็บเป็นเวลานานให้เก็บแบตเตอรี่ที่ชาร์จเต็มแล้วในสถานที่แห้งและเย็นนอกเครื่องชาร์จ

**หมายเหตุ:** ไม่ควรเก็บรักษาแบตเตอรี่ในสภาพปราศจากประจุโดยสิ้นเชิง จำเป็นต้องชาร์จแบตเตอรี่ใหม่อีกครั้งก่อนใช้งาน

**แผ่นป้ายบนแบตเตอรี่และเครื่องชาร์จ**

นอกเหนือจากสัญลักษณ์ภาพที่ใช้ในคู่มือเล่มนี้แล้ว บนเครื่องชาร์จและแบตเตอรี่จะมีสัญลักษณ์ภาพดังต่อไปนี้:



โปรดอ่านคู่มือแนะนำการใช้ก่อนใช้งาน



กำลังชาร์จไฟ



ชาร์จเต็มแล้ว



หยุดพักเนื่องจากแบตเตอรี่ร้อนเกินไป



แบตเตอรี่หรือเครื่องชาร์จชำรุด



สายไฟตัวเครื่องชำรุด



ห้ามแยกด้วยวัตถุที่เป็นตัวนำ



ห้ามชาร์จแบตเตอรี่ที่ชำรุด



ให้ใช้เฉพาะแบตเตอรี่ของ DeWALT เท่านั้น  
แบตเตอรี่ชนิดอื่นๆ อาจทำให้แบตเตอรี่ระเบิด  
เป็นเหตุให้เกิดการบาดเจ็บและความเสียหายได้



ห้ามทำให้แบตเตอรี่เปียกน้ำ



เปลี่ยนสายไฟที่ชำรุดทันที



ชาร์จไฟที่อุณหภูมิระหว่าง 4 °C ถึง 40 °C เท่านั้น



โปรดทิ้งแบตเตอรี่อย่างเหมาะสมโดยคำนึงถึงผลกระทบต่อสิ่งแวดล้อม



ห้ามเผาแบตเตอรี่



ชาร์จแบตเตอรี่ LI-ION



โปรดดูเวลาในการชาร์จจากข้อมูลทางเทคนิค



สำหรับใช้ในอาคารเท่านั้น

## สิ่งที่อยู่ในบรรจุภัณฑ์

ภายในบรรจุภัณฑ์ประกอบด้วย:

ส่วนไขควง 1 เครื่อง หรือส่วนไขควง/ส่วนเจาะกระแทก  
1 เครื่อง

เครื่องชาร์จ 1 เครื่อง

แบตเตอรี่ Li-ION 1 ก้อน (สำหรับรุ่น C1)

แบตเตอรี่ Li-ION 2 ก้อน (สำหรับรุ่น C2)

แบตเตอรี่ Li-ION 3 ก้อน (สำหรับรุ่น C3)

กล่องเครื่องมือ 1 กล่อง

คู่มือการใช้งาน 1 ฉบับ

**หมายเหตุ:** รุ่น N จะไม่มีแบตเตอรี่ เครื่องชาร์จ และกล่อง  
เครื่องมือให้มาด้วย

- โปรดตรวจสอบร่องรอยความเสียหายของเครื่องมือ ชิ้นส่วน  
หรืออุปกรณ์เสริม ที่อาจเกิดขึ้นในระหว่างการขนส่ง
- โปรดอ่านและทำความเข้าใจคู่มือเล่มนี้ก่อนการใช้งาน

## คำอธิบาย (รูป 1)



**คำเตือน:** ห้ามปรับแต่งเครื่องมือไฟฟ้าหรือชิ้นส่วนใดๆ โดย  
เด็ดขาด เพราะอาจทำให้เครื่องมือชำรุดหรือได้รับบาดเจ็บได้

- สวิตช์
- ปุ่มควบคุมเดินหน้า/ถอยหลัง
- ตัวปรับแรงบิด
- สวิตช์เปลี่ยนเกียร์
- ไฟส่องงาน
- ตัวจับดอกสว่านแบบไม่ใช้จำปา
- แบตเตอรี่
- ปุ่มปลดล็อกแบตเตอรี่
- มือจับหลัก

## วัตถุประสงค์ในการใช้งาน

ส่วนไขควง/ส่วนเจาะกระแทกเหล่านี้ได้รับการออกแบบ  
สำหรับการเจาะแบบมีออสซีฟ การเจาะกระแทก และการขันน็อต

ห้ามใช้ในบริเวณที่เปียกชื้น หรือมีของเหลวหรือแก๊สที่ติดไฟ  
ได้ภายในบริเวณดังกล่าว

ส่วนไขควง/ส่วนเจาะกระแทกเป็นเครื่องมือไฟฟ้าสำหรับ  
มีออสซีฟ

ห้ามปล่อยให้เด็กสัมผัสกับเครื่องมือ ผู้ใช้งานที่ไม่มี

ประสบการณ์มาก่อนต้องได้รับการดูแลขณะใช้เครื่องมือนี้

- เครื่องมือนี้ไม่ได้มีไว้เพื่อการใช้งานโดยบุคคล (ซึ่งรวมถึงผู้เยาว์)  
ที่มีความบกพร่องทางร่างกาย ทางการรับรู้ความรู้สึก หรือทาง  
จิตประสาท หรือขาดประสบการณ์ ความรู้ และทักษะ เว้นเสีย  
แต่จะได้รับการควบคุมดูแลหรือคำแนะนำการใช้เครื่องมือโดย  
ผู้ที่รับผิดชอบต่อความปลอดภัยของบุคคลเหล่านั้น ห้ามปล่อยให้  
ผู้เยาว์ไว้กับเครื่องมือนี้ตามลำพัง

## ความปลอดภัยทางไฟฟ้า

มอเตอร์ไฟฟ้าออกแบบมาเพื่อใช้กับแรงดันไฟฟ้าขนาดเดียว  
เท่านั้น ต้องตรวจสอบแรงดันไฟฟ้าของแบตเตอรี่ให้ตรงกับ  
แรงดันไฟฟ้าบนแผ่นแสดงพิกัดเสมอ รวมทั้งตรวจสอบว่าแรง  
ดันไฟฟ้าของเครื่องชาร์จตรงกับสายไฟตัวเครื่องของคุณ



เครื่องชาร์จ DEWALT ใช้ระบบฉนวนสองชั้นตาม  
มาตรฐาน IEC 60335 จึงไม่จำเป็นต้องใช้สายดิน

ถ้าสายไฟของตัวเครื่องชำรุดเสียหาย ต้องเปลี่ยนเป็นสายไฟ  
ที่จัดเตรียมมาเป็นพิเศษซึ่งสั่งซื้อได้จากศูนย์บริการของ DEWALT

## การใช้สายต่อพ่วง

ไม่ควรใช้สายต่อพ่วง เว้นแต่มีความจำเป็นอย่างหลีกเลี่ยงไม่ได้ ควรใช้สายต่อพ่วงที่ผ่านการรับรองและเหมาะสมกับกำลังไฟเข้าของเครื่องชาร์จ (ดูข้อมูลด้านเทคนิค) ขนาดต่ำสุดของสายไฟ คือ 1 ตร.มม. ความยาวสูงสุด คือ 30 ม.

เมื่อมีการใช้อุปกรณ์มีแรงเก็บสายไฟ ให้คลายสายไฟออกจนหมดทุกครั้ง

## การประกอบและการปรับตั้ง



**คำเตือน:** เพื่อลดความเสี่ยงของการบาดเจ็บสาหัส ให้ปิดเครื่องมือและถอดแบตเตอรี่ก่อนทำการปรับหรือการถอด/ติดตั้งอุปกรณ์ต่อพ่วงหรืออุปกรณ์เสริมใด ๆ การถอดเปิดเครื่องโดยไม่ตั้งใจอาจเป็นสาเหตุให้เกิดการบาดเจ็บได้



**คำเตือน:** ใช้แบตเตอรี่และเครื่องชาร์จของ DEWALT เท่านั้น

## การใส่และการถอดแบตเตอรี่ออกจากเครื่องมือ (รูป 2)



**คำเตือน:** ก่อนที่จะประกอบและปรับตั้ง ให้ถอดแบตเตอรี่ออกจากทุกครั้ง ปิดสวิตช์เครื่องมือเสมอ ก่อนใส่หรือถอดแบตเตอรี่

**หมายเหตุ:** เพื่อให้การทำงานได้ผลดีที่สุดควรชาร์จแบตเตอรี่ให้เต็ม

เมื่อต้องการใส่แบตเตอรี่ลงในตัวจับของเครื่องมือ

- วางแบตเตอรี่ (g) ให้ตรงกับรางภายในตัวจับของเครื่องมือ (รูป 2)
- เลื่อนแบตเตอรี่เข้าไปในตัวจับจนกระทั่งแบตเตอรี่เข้าไปอยู่ในเครื่องมือสนิทดี และตรวจสอบให้แน่ใจว่าแบตเตอรี่จะไม่เลื่อนหลุดออก

เมื่อต้องการถอดแบตเตอรี่ออกจากเครื่องมือ

- กดปุ่มปลดล็อกแบตเตอรี่ (h) จากนั้นจับแบตเตอรี่ให้กระชับและดึงออกจากตัวจับ
- ใส่แบตเตอรี่ลงในเครื่องชาร์จตามที่บรรยายในส่วนหนึ่งของเครื่องชาร์จในคู่มือฉบับนี้

## แบตเตอรี่ที่มีตัวบอกระดับประจุ (รูป 2)

แบตเตอรี่ DEWALT บางรุ่นมีตัวบอกระดับประจุซึ่งประกอบด้วยไฟ LED สีเขียวสามดวงที่ตัวบอกระดับของประจุที่เหลืออยู่ในแบตเตอรี่

ถ้าต้องการให้ตัวบอกระดับประจุนี้งาน ให้กดปุ่มตัวบอกระดับประจุ (k) ค้างไว้ ไฟ LED สามดวงนี้จะติดสว่างใน

ลักษณะที่สามารถบอกระดับประจุที่เหลืออยู่ได้ เมื่อระดับของประจุในแบตเตอรี่ต่ำกว่าขีดจำกัดที่ใช้งานได้ ตัวบอกระดับประจุจะไม่ติดสว่าง และจะต้องชาร์จแบตเตอรี่ใหม่

**หมายเหตุ:** ตัวบอกระดับประจุเป็นเพียงตัวบอกระดับประจุที่เหลืออยู่ในแบตเตอรี่เท่านั้น ไม่ได้รับประกันการทำงานของเครื่องมือ และอาจมีการเปลี่ยนแปลงขึ้นกับส่วนประกอบของผลิตภัณฑ์ อุดหนุน และการใช้งานของผู้ใช้

## สวิตช์สำหรับปรับระดับความเร็ว (รูป 1)

เมื่อต้องการเปิดเครื่องมือ ให้บีบสวิตช์ (a) เมื่อต้องการปิดเครื่องมือให้ปล่อยสวิตช์ เครื่องมือนี้มีเบรกติดตั้งอยู่ ตัวจับดอกสว่านจะหยุดทำงานทันทีที่ปล่อยสวิตช์จนสุด

**หมายเหตุ:** ไม่แนะนำให้ใช้การปรับระดับความเร็วอย่างต่อเนื่องเป็นเวลานาน การใช้งานลักษณะนี้อาจทำให้สวิตช์เสียหายได้ และควรหลีกเลี่ยง

## ปุ่มควบคุมเดินหน้า/ถอยหลัง (รูป 1)

ปุ่มควบคุมเดินหน้า/ถอยหลัง (b) จะควบคุมทิศทางการทำงานของเครื่องมือ รวมทั้งทำหน้าที่เป็นปุ่มล็อกให้อยู่ในตำแหน่งปิดอีกด้วย

หากต้องการเลือกทิศทางการหมุนไปด้านหน้า ให้ปล่อยสวิตช์แล้วกดปุ่มควบคุมเดินหน้า/ถอยหลังไปทางด้านขวาของเครื่องมือ

หากต้องการเลือกทิศทางการหมุนไปด้านหลัง ให้กดปุ่มควบคุมเดินหน้า/ถอยหลังไปทางด้านซ้ายของเครื่องมือ

ตำแหน่งตรงกลางของปุ่มควบคุมจะใช้ล็อกเครื่องมือให้อยู่ในตำแหน่งปิดการทำงาน เมื่อจะเปลี่ยนตำแหน่งของปุ่มควบคุม ต้องแน่ใจว่าได้ปล่อยสวิตช์แล้ว

**หมายเหตุ:** คุณอาจได้ยินเสียงกริกเมื่อเดินเครื่องครั้งแรก หลังจากเปลี่ยนทิศทางการหมุน นี่เป็นสภาพปกติของเครื่องมือและไม่ได้แสดงว่าเครื่องเกิดปัญหาแต่อย่างใด

## ปลอกปรับแรงบิด (รูป 1)

เครื่องมือของคุณมีกลไกของไขควงที่ปรับแรงบิดได้เพื่อใช้สำหรับขันหรือคลายตัวยึดที่มีรูปร่างและขนาดต่างๆ และในบางรุ่น มีกลไกดอกกระแทกสำหรับเจาะเข้าไปในปูน รอบปลอกปรับ (c) นี้มีตัวเลข สัญลักษณ์ดอกสว่าน และในบางรุ่น มีสัญลักษณ์ค้อนด้วย ตัวเลขเหล่านี้ใช้ในการตั้งค่าคลัตช์เพื่อส่งช่วงของแรงบิด ตัวเลขยิ่งมาก แรงบิดจะยิ่งสูง และสามารถ

ขันด้วยยึดได้ใหญ่ขึ้นด้วย ถ้าต้องการเลือกตัวเลขใด ให้หมุน ปลอกจนกระทั่งตัวเลขที่ต้องการหมุนมาตรงกับลูกศร

### เกียร์สองจังหวะ (รูป 1)

เกียร์สองจังหวะของสว่านไขควง/สว่านเจาะกระแทกนี้ช่วยให้คุณสามารถเปลี่ยนเกียร์เพื่อให้ใช้งานได้หลากหลายขึ้น

1. ถ้าต้องการเลือกเกียร์ 1 (ตั้งค่าแรงบิดสูง) ให้ปิดเครื่องมือและปล่อยให้เครื่องหยุดหมุนเอง เลื่อนสวิตช์เปลี่ยนเกียร์ (d) ไปข้างหน้า (ไปทางตัวจับดอกสว่าน)
2. ถ้าต้องการเลือกเกียร์ 2 (ตั้งค่าแรงบิดต่ำ) ให้ปิดเครื่องมือและปล่อยให้เครื่องหยุดหมุนเอง เลื่อนสวิตช์เปลี่ยนเกียร์ไปข้างหลัง (ออกห่างตัวจับดอกสว่าน)

**หมายเหตุ:** อย่าเปลี่ยนเกียร์ขณะที่เครื่องกำลังทำงาน ปล่อยให้สว่านหยุดสนิทก่อนแล้วจึงเปลี่ยนเกียร์ ถ้าคุณมีปัญหาในการเปลี่ยนเกียร์ ให้ตรวจสอบให้แน่ใจว่าสวิตช์เปลี่ยนเกียร์อยู่ในตำแหน่งใดตำแหน่งหนึ่งระหว่างถูกดันไปข้างหน้าจนสุดหรือถูกดันถอยหลังจนสุด

### ไฟส่องงาน (รูป 1)

มีไฟส่องงาน (e) อยู่เหนือสวิตช์ (a) ไฟส่องงานจะติดสว่างเมื่อสวิตช์ถูกกด เมื่อปล่อยสวิตช์ ไฟส่องงานจะยังคงสว่างต่อไปอีกไม่เกิน 20 วินาที

**หมายเหตุ:** ไฟส่องงานใช้สำหรับส่องบริเวณที่ทำงานเบื้องหน้าเท่านั้น ไม่ใช้สำหรับใช้เป็นไฟฉาย

### ตัวจับดอกสว่านแบบไม้ใช้จำปา (รูป 7-9)



**คำเตือน:** อย่าพยายามขันดอกสว่าน (หรืออุปกรณ์เสริมใดๆ) ให้แน่นด้วยการจับที่ด้านหน้าของตัวจับดอกสว่านแล้วเปิดเครื่องมือ เพราะอาจทำให้ตัวจับดอกสว่านเสียหายหรือเกิดการบาดเจ็บได้ ให้ล็อคสวิตช์เสมอ และไม่ให้เครื่องมือเชื่อมต่อกับแหล่งจ่ายไฟขณะที่เปลี่ยนอุปกรณ์เสริม



**คำเตือน:** ตรวจสอบให้แน่ใจทุกครั้งว่าได้ยึดดอกสว่านแน่นดีแล้วก่อนเริ่มใช้เครื่องมือ ดอกสว่านที่จับไม่แน่นอาจดีดออกจากเครื่องมือทำให้อาจเกิดการบาดเจ็บได้

เครื่องมือของคุณมีตัวจับดอกสว่านแบบไม้ใช้จำปา (f) และมีปลอกแบบหมุนทางเดียวเพื่อให้สามารถหมุนตัวจับดอกสว่านด้วยมือเดียวได้ ถ้าต้องการใส่ดอกสว่านหรืออุปกรณ์เสริม ให้ทำตามขั้นตอนต่อไปนี้

1. ปิดเครื่องมือและถอดปลั๊ก
2. จับปลอกสีข้างของตัวจับดอกสว่านด้วยมือข้างหนึ่ง และใช้มืออีกข้างหนึ่งยึดเครื่องมือให้แน่น หมุนปลอกทวนเข็มนาฬิกาให้กว้างพอที่จะใส่อุปกรณ์เสริมที่ต้องการได้
3. ใส่อุปกรณ์เสริมให้เข้าไปในตัวจับดอกสว่านประมาณ 19 มม. (3/4SDSq) และขันให้แน่นด้วยการหมุนปลอกของตัวจับดอกสว่านตามเข็มนาฬิกาด้วยมือข้างหนึ่งขณะที่จับเครื่องมือด้วยมืออีกข้างหนึ่ง เครื่องมือนี้มียกไกล็อคแกนหมุนอัตโนมัติ จึงทำให้คุณสามารถเปิดและปิดตัวจับดอกสว่านได้ด้วยมือเดียว

ต้องแน่ใจว่าได้ขันตัวจับดอกสว่านให้แน่นแล้วโดยที่มีมือข้างหนึ่งจับอยู่ที่ปลอกของตัวจับและมืออีกข้างหนึ่งจับเครื่องมือไว้เพื่อให้เกิดความแน่นสูงสุด

ถ้าต้องการปลดล๊อคอุปกรณ์เสริม ให้ทำซ้ำขั้นที่ 1 และ 2 ข้างต้น

### การใช้งาน

#### วิธีการใช้เครื่อง



**คำเตือน:** ทำตามข้อปฏิบัติเพื่อความปลอดภัยและข้อกำหนดที่ให้ไว้เสมอ



**คำเตือน:** เพื่อลดความเสี่ยงของการบาดเจ็บสาหัส ให้ปิดเครื่องมือและถอดแบตเตอรี่ก่อนทำการปรับหรือการถอด/ติดตั้งอุปกรณ์ต่อพ่วงหรืออุปกรณ์เสริมใดๆ การผล็องเปิดเครื่องโดยไม่ได้ตั้งใจอาจเป็นสาเหตุให้เกิดการบาดเจ็บได้

### ตำแหน่งการจับที่ถูกต้อง (รูป 3)



**คำเตือน:** เพื่อลดความเสี่ยงจากการได้รับบาดเจ็บสาหัส ให้จับเครื่องมือในตำแหน่งที่ถูกต้องดังแสดงในภาพเสมอ



**คำเตือน:** เพื่อลดความเสี่ยงจากการได้รับบาดเจ็บสาหัส จะต้องจับเครื่องมือให้แน่นทุกครั้ง เพื่อเตรียมพร้อมสำหรับแรงปฏิกิริยาที่เกิดขึ้นแบบทันทีทันใด

ตำแหน่งการจับที่ถูกต้องจะต้องให้มือข้างหนึ่งอยู่บนส่วนบนสุดของสว่านตามที่แสดงในภาพ และมืออีกข้างหนึ่งอยู่บนมือจับหลัก (i)

### การทำงานขั้น (รูป 4)

1. เลือกช่วงความเร็ว/แรงบิดที่ต้องการโดยใช้ตัวเลือกเกียร์สองจังหวะเพื่อให้ตรงกับความเร็วและแรงบิดของการทำงานที่วางแผนไว้

2. หมุนปลอกปรับแรงบิด (c) ไปยังตำแหน่งที่ต้องการ ตัวเลขน้อยหมายถึงแรงบิดน้อย ตัวเลขมากหมายถึงแรงบิดมาก
3. ใส่อุปกรณ์เสริมตัวยึดที่ต้องการลงในตัวจับดอกสว่านแบบเดียวกับการใส่ดอกสว่านทั่วไป
4. ลองฝึกกับเศษวัสดุหรือกับบริเวณที่มองไม่เห็นก่อน เพื่อหาตำแหน่งที่เหมาะสมของปลอกคัตช์
5. ให้เริ่มด้วยค่าแรงบิดต่ำก่อนทุกครั้ง แล้วเพิ่มแรงบิดให้สูงขึ้นเพื่อหลีกเลี่ยงความเสียหายที่จะเกิดกับชิ้นงานหรือตัวยึด

### การทำงานเจาะ (รูป 5)



**คำเตือน:** เพื่อลดความเสี่ยงของการบาดเจ็บสาหัส ให้ปิดเครื่องมือและถอดปลั๊กออกจากแหล่งจ่ายไฟก่อนทำการปรับหรือการถอด/ติดตั้งอุปกรณ์ต่อพ่วงหรืออุปกรณ์เสริมใดๆ



**คำเตือน:** เพื่อลดความเสี่ยงจากการได้รับบาดเจ็บให้ตรวจสอบทุกครั้งว่าได้ยึดหรือจับชิ้นงานไว้แน่นหนาดีแล้ว หากเจาะวัสดุบาง ให้ออกด้วยตนเองเพื่อป้องกันไม่ให้วัสดุเสียหาย

1. หมุนปลอก (c) ไปที่สัญลักษณ์รูปสว่าน
2. เลือกช่วงความเร็วแรงบิดที่ต้องการโดยใช้สวิตช์เปลี่ยนเกียร์เพื่อให้ตรงกับความเร็วและแรงบิดของการทำงานที่วางแผนไว้
3. สำหรับไม้ ให้ใช้ดอกสว่านแบบเกลียว ดอกสว่านแบบพลาว์ ดอกสว่านแบบใบสว่านเกลียว หรือเลื่อยสำหรับเจาะรู สำหรับโลหะ ให้ใช้ดอกสว่านแบบเกลียวสำหรับงานเหล็ก หรือเลื่อยสำหรับเจาะรู ใช้สารหล่อลื่นสำหรับงานตัดขณะเจาะโลหะ ยกเว้นเหล็กหล่อและทองเหลืองที่ควรเจาะขณะแห้ง
4. ออกแรงกดตรงๆ ไปที่ดอกสว่านเสมอ ใช้แรงดันพอสมควรเพื่อให้สว่านทำงาน แต่ต้องไม่ออกแรงมากเกินไปจนมอเตอร์หยุดกลางคันหรือดอกสว่านบิด
5. ถือเครื่องมือด้วยมือทั้งสองข้างเพื่อควบคุมการหมุนเป็นเกลียวของดอกสว่าน ถ้าสว่านรุ่นที่ใช้ไม่มีมือจับเสริมด้านข้าง ให้จับสว่านโดยที่มือข้างหนึ่งอยู่บนมือจับเสริมด้านข้างและมืออีกข้างหนึ่งอยู่บนแบตเตอรี่



**ข้อควรระวัง:** สว่านอาจหยุดกลางคันถ้าทำงานหนักเกินไปซึ่งจะทำให้เกิดการบิดทันที เตรียมพร้อมหากเครื่องมือหยุดกลางคัน จับสว่านให้แน่นเพื่อควบคุมการสลับและไม่ให้เกิดการบาดเจ็บ

6. ถ้าสว่านหยุดกลางคัน มักเป็นเพราะใช้งานเกินกำลังหรือใช้งานไม่ถูกต้อง ให้ปล่อยสวิตช์ทันที และถอนดอกสว่านออกจากชิ้นงาน แล้วหาสาเหตุที่ทำให้เครื่องหยุด ห้ามเปิด

และปิดสวิตช์เพื่อพยายามให้ส่วนที่หยุดกลางคันเริ่มทำงาน เพราะอาจทำให้ส่วนชำรุดเสียหายได้

7. เพื่อให้การหยุดกลางคันหรือการทำให้วัสดุแตกหักเหลือน้อยที่สุด ให้ลดแรงกดที่กระทำต่อสว่านและคลายดอกสว่านผ่านทางรูของชิ้นงาน
8. มอเตอร์ต้องทำงานอยู่ในขณะที่ดึงดอกสว่านย้อนออกมาจากรูที่เจาะไว้ วิธีนี้จะป้องกันปัญหาดอกสว่านติดได้
9. ไม่จำเป็นต้องหาจุดกึ่งกลางที่จะเจาะเนื่องจากสว่านมีความเร็วหลายระดับ ใช้ความเร็วต่ำก่อนเพื่อเริ่มเจาะรู และเร่งความเร็วด้วยการกดที่สวิตช์ให้แรงขึ้นเมื่อรูที่เจาะลึกพอที่จะเจาะต่อ โดยที่ดอกสว่านไม่กระเด็นออกมา

### การทำงานเจาะกระแทก (รูป 6)

#### DCD776

1. หมุนปลอก (c) ไปที่สัญลักษณ์รูปสว่านเจาะกระแทก
  2. เลือกค่าความเร็วสูงโดยเลื่อนสวิตช์เปลี่ยนเกียร์ไปยังหลัง (ออกห่างตัวจับดอกสว่าน)
- ข้อสำคัญ:** ใช้ดอกสว่านหัวคาร์ไบด์หรือดอกสว่านเจาะปูนเท่านั้น
3. เจาะด้วยแรงกดพอสมควรเพื่อให้สว่านกระดอนมากเกินไปหรือไม่เหวี่ยงดอกสว่าน “โผล่” ออกมา การใช้แรงมากเกินไปจะทำให้ความเร็วในการเจาะลดลง เกิดความร้อนมากเกินไปและอัตราการเจาะต่ำลง
  4. เจาะให้ตรง คอยดูให้ดอกสว่านตั้งฉากกับงานตลอดเวลา ย่อออกแรงกดดอกสว่านทางด้านข้างขณะเจาะเพราะจะทำให้ดอกสว่านติดอยู่ในร่องและความเร็วในการเจาะช้าลง
  5. ขณะเจาะรูลึก ถ้าความเร็วของสว่านเริ่มลดลง ให้ถอนสว่านออกจากรูบางส่วนโดยที่เครื่องมือยังคงทำงานอยู่ ทั้งนี้เพื่อช่วยจัดเศษวัสดุออกจาก

**หมายเหตุ:** ฝุ่นที่ออกมาจากรูอาจต้องเนื่องบ่งบอกถึงอัตราการเจาะที่เหมาะสม

### การบำรุงรักษา

เครื่องมือไฟฟ้า DEWALT ออกแบบมาเพื่อให้สามารถใช้งานได้อย่างยาวนานโดยมีการบำรุงรักษาที่ดีที่สุด การทำงานที่สร้างความพึงพอใจอย่างต่อเนื่องจะขึ้นอยู่กับการดูแลรักษาที่เหมาะสมและการทำความสะอาดอย่างสม่ำเสมอ



**คำเตือน:** เพื่อลดความเสี่ยงของการบาดเจ็บสาหัส ให้ปิดเครื่องมือและถอดแบตเตอรี่ก่อนทำการปรับหรือการถอด/ติดตั้งอุปกรณ์ต่อพ่วงหรืออุปกรณ์เสริมใดๆ การผล็อบเปิด

เครื่องโดยไม่ได้ตั้งใจอาจเป็นสาเหตุให้เกิดการบาดเจ็บได้

เครื่องชาร์จและแบตเตอรี่ไม่สามารถซ่อมแซมได้ ภายในอุปกรณ์ทั้งสองไม่มีชิ้นส่วนใดที่สามารถซ่อมแซมได้



### การหล่อลื่น

ไม่ต้องใช้สารหล่อลื่นเพิ่มเติมกับเครื่องมือไฟฟ้านี้



### การทำความสะอาด



**คำเตือน:** เป่าสิ่งสกปรกและฝุ่นละอองที่สะสมออกจากตัวเครื่องเป็นประจำด้วยลมแห้ง เนื่องจากสิ่งสกปรกมักสะสมอยู่ภายในและรอบๆ ของระบายอากาศ สวมอุปกรณ์ป้องกันดวงตาและหน้ากากกันฝุ่นที่ได้มาตรฐานในขณะดำเนินการขั้นตอนนี้



**คำเตือน:** ห้ามใช้สารที่เป็นตัวทำลายหรือสารเคมีที่มีฤทธิ์กัดกร่อนรุนแรงอื่นๆ ทำความสะอาดชิ้นส่วนของเครื่องมือที่ไม่ใช่โลหะ สารเคมีเหล่านี้อาจส่งผลต่อวัสดุที่ใช้ในชิ้นส่วนเหล่านี้ โดยเฉพาะผ้าชุบน้ำสบู่อ่อนๆ เท่านั้น อย่าให้มีของเหลวใดๆ เข้าไปในเครื่องมือเด็ดขาด ห้ามจุ่มส่วนใด ๆ ของเครื่องมือลงในของเหลวเด็ดขาด

### คำแนะนำสำหรับการทำความสะอาดเครื่องชาร์จ



**คำเตือน:** อันตรายจากการถูกไฟฟ้าช็อต ถอดเครื่องชาร์จออกจากเต้ารับไฟบ้านก่อนทำความสะอาด ให้จัดสิ่งสกปรกและจาระบีออกจากภายนอกของเครื่องชาร์จโดยใช้ผ้าหรือแปรงขนนุ่มที่ไม่ใช่โลหะ ห้ามใช้น้ำหรือน้ำยาทำความสะอาดใดๆ

### อุปกรณ์เสริม



**คำเตือน:** เนื่องจากอุปกรณ์เสริมอื่นนอกเหนือจากที่ DEWALT เสนอไม่ได้ผ่านการทดสอบร่วมกับผลิตภัณฑ์นี้ จึงอาจเป็นอันตรายหากใช้อุปกรณ์เสริมดังกล่าวร่วมกับเครื่องมือนี้ ดังนั้น เพื่อลดความเสี่ยงจากการได้รับบาดเจ็บ ให้ใช้อุปกรณ์เสริมเฉพาะที่ DEWALT แนะนำให้ใช้กับผลิตภัณฑ์นี้เท่านั้น

โปรดติดต่อตัวแทนจำหน่ายหากต้องการข้อมูลเพิ่มเติมเกี่ยวกับอุปกรณ์เสริมที่เหมาะสม

### การปกป้องสิ่งแวดล้อม



การเก็บรวบรวมแบบคัดแยก ห้ามทิ้งผลิตภัณฑ์นี้ร่วมกับขยะในครัวเรือนปกติ

หากวันหนึ่งคุณจำเป็นต้องเปลี่ยนผลิตภัณฑ์ DEWALT ของคุณ หรือเครื่องมือนี้ไม่เป็นประโยชน์สำหรับคุณอีกต่อไป อย่าทิ้งผลิตภัณฑ์นี้ร่วมกับขยะในครัวเรือน จัดการกับผลิตภัณฑ์นี้เพื่อให้พร้อมสำหรับการคัดแยกขยะ



การเก็บรวบรวมแบบคัดแยกสำหรับบรรจุภัณฑ์ และผลิตภัณฑ์ที่ใช้แล้วทำให้สามารถรีไซเคิลวัสดุและนำมาใช้งานได้อีกครั้ง การนำวัสดุรีไซเคิลมาใช้ใหม่จะช่วยป้องกันมลพิษต่อสิ่งแวดล้อมและลดความต้องการวัตถุดิบ

ตามกฎระเบียบท้องถิ่นอาจมีการจัดเตรียมสถานที่สำหรับการเก็บรวบรวมแบบคัดแยกอุปกรณ์ไฟฟ้าที่ใช้ภายในครัวเรือนไว้ ณ แหล่งรับขยะของเทศบาล หรืออาจมีการรับอุปกรณ์ใช้แล้วจากผู้ค้าปลีกในกรณีที่คุณซื้อผลิตภัณฑ์ชิ้นใหม่

คุณสามารถตรวจสอบที่อยู่ของตัวแทนซ่อมที่ได้รับอนุญาตที่อยู่ใกล้คุณมากที่สุดได้โดยการติดต่อสำนักงานของ DEWALT ในพื้นที่ของคุณตามที่อยู่ระบุในคู่มือนี้ หรือ คุณอาจตรวจสอบเช็ครายชื่อศูนย์บริการ DEWALT ที่ได้รับอนุญาต รวมทั้งรายละเอียดต่างๆ ของบริการหลังการขายได้ทางอินเทอร์เน็ต ที่:

[www.2helpU.com](http://www.2helpU.com)



### แบตเตอรี่แบบชาร์จซ้ำได้

แบตเตอรี่ที่มีอายุการใช้งานยาวนานจำเป็นต้องรับการชาร์จไฟใหม่เมื่อไม่สามารถจ่ายพลังงานเพียงพอสำหรับการทำงานซึ่งเคยทำได้โดยง่าย เมื่อแบตเตอรี่หมดอายุการทำงานทางด้านเทคนิคแล้ว ให้นำแบตเตอรี่ไปกำจัดทิ้งโดยคำนึงถึงผลกระทบต่อสิ่งแวดล้อม:

- ใช้แบตเตอรี่ให้หมดเกลี้ยง จากนั้นถอดแบตเตอรี่ออกจากเครื่องมือ
- แบตเตอรี่ Li-ION สามารถรีไซเคิลได้ โปรดนำไปที่ตัวแทนจำหน่ายหรือสถานีรีไซเคิลในพื้นที่ของคุณ แบตเตอรี่ที่เรารวบรวมได้จะนำไปรีไซเคิลหรือกำจัดอย่างเหมาะสมต่อไป

# MÁY KHOAN ĐỘNG LỰC CHẠY PIN 13 mm (1/2 INCH) DCD734, DCD771, DCD776

## Xin chúc mừng!

Bạn đã chọn thiết bị của DEWALT. Qua nhiều năm kinh nghiệm, những đổi mới và phát triển sản phẩm một cách toàn diện đã khiến DEWALT trở thành một trong những đối tác tin cậy nhất đối với người sử dụng dụng cụ điện cầm tay chuyên nghiệp.

## Thông số kỹ thuật

		DCD734	DCD771	DCD776
Điện áp	$V_{DC}$	14,4	18	18
Loại		1	1	1
Loại pin		Li-ION	Li-ION	Li-ION
Công suất đầu ra	W	250	300	300
Tốc độ không tải				
số 1	phút <sup>1</sup>	0-400	0-450	0-450
số 2	phút <sup>1</sup>	0-1300	0-1500	0-1500
Tốc độ va đập				
số 1	phút <sup>1</sup>	–	–	0-7650
số 2	phút <sup>1</sup>	–	–	0-25 500
Mô men tối đa (cứng/mềm)	Nm	38/22	42/24	42/24
Kích thước đầu kẹp	mm	13	13	13
Công suất khoan tối đa				
Gỗ	mm	30	30	30
Kim loại	mm	10	13	13
Tường	mm	–	–	13
Trọng lượng (chưa bao gồm pin)	kg	1,2	1,3	1,34

Pin		DCB140	DCB141	DCB142	DCB143	DCB145
Loại pin		Li-ION	Li-ION	Li-ION	Li-ION	Li-ION
Điện áp	$V_{DC}$	14,4	14,4	14,4	14,4	14,4
Dung lượng	$A_h$	3,0	1,5	4,0	2,0	1,3
Trọng lượng	kg	0,53	0,30	0,54	0,30	0,30
Pin		DCB185	DCB181	DCB183	DCB180	DCB182
Loại pin		Li-ION	Li-ION	Li-ION	Li-ION	Li-ION
Điện áp	$V_{DC}$	18	18	18	18	18
Dung lượng	$A_h$	1,3	1,5	2,0	3,0	4,0
Trọng lượng	kg	0,35	0,35	0,40	0,64	0,61

Bộ sạc		DCB107				
Điện áp nguồn	$V_{AC}$	230 V				
Loại pin		Li-ION				
Thời gian sạc xấp xỉ	phút	60 (pin 1,3 Ah loại)	70 (pin 1,5 Ah loại)	90 (pin 2,0 Ah loại)	140 (pin 3,0 Ah loại)	185 (pin 4,0 Ah loại)
Trọng lượng	kg	0,49				

## Định nghĩa: Hướng dẫn an toàn

Các định nghĩa dưới đây mô tả mức độ nghiêm trọng của từng ký hiệu. Vui lòng đọc hướng dẫn sử dụng và chú ý đến các ký hiệu này.



**NGUY HIỂM:** Chỉ tình huống nguy hiểm tiềm ẩn mà, nếu không phòng tránh, sẽ gây tử vong hoặc chấn thương nghiêm trọng.



**CẢNH BÁO:** Chỉ tình huống nguy hiểm tiềm ẩn mà, nếu không phòng tránh, có thể gây tử vong hoặc chấn thương nghiêm trọng.



**THẬN TRỌNG:** Chỉ tình huống nguy hiểm tiềm ẩn mà, nếu không phòng tránh, có thể gây chấn thương vừa hoặc nhẹ.

**LƯU Ý:** Chỉ một hoạt động không liên quan đến chấn thương cá nhân mà, nếu không phòng tránh, có thể gây hư hỏng tài sản.



Biểu thị nguy cơ bị điện giật.



Biểu thị nguy cơ hỏa hoạn.



**CẢNH BÁO:** Để giảm nguy cơ chấn thương, hãy đọc hướng dẫn sử dụng.

## Cảnh báo chung về an toàn đối với dụng cụ điện cầm tay



**CẢNH BÁO!** Hãy đọc tất cả các cảnh báo và hướng dẫn về an toàn. Việc không tuân theo các cảnh báo và hướng dẫn có thể gây điện giật, hỏa hoạn và/hoặc chấn thương nghiêm trọng.

### GIỮ LẠI TẤT CẢ CÁC CẢNH BÁO VÀ HƯỚNG DẪN ĐỂ THAM KHẢO VỀ SAU

Thuật ngữ “dụng cụ điện cầm tay” trong phần cảnh báo chỉ thiết bị chạy bằng điện nguồn (có dây điện) hoặc thiết bị chạy bằng pin (không có dây điện).

#### 1) AN TOÀN TẠI NƠI LÀM VIỆC

- Giữ cho nơi làm việc luôn sạch sẽ và đủ ánh sáng.** Những khu vực bừa bộn hoặc thiếu ánh sáng dễ gây tai nạn.
- Không vận hành dụng cụ điện cầm tay trong các môi trường dễ cháy nổ, như các môi trường có chất lỏng, khí ga hoặc bụi dễ cháy.** Dụng cụ điện cầm tay tạo ra các tia lửa điện có thể gây cháy bụi hoặc bốc khói.
- Không cho trẻ em và những người quan sát lại gần khi đang vận hành dụng cụ điện cầm tay.** Những lúc xao lãng có thể khiến bạn mất kiểm soát.

#### 2) AN TOÀN ĐIỆN

- Phích cắm của dụng cụ điện cầm tay phải vừa với ổ cắm. Không sửa đổi phích cắm bằng bất kỳ cách nào. Không sử dụng các phích cắm tiếp hợp với những dụng cụ điện cầm tay có nối đất.** Phích cắm nguyên trạng và ổ cắm phù hợp sẽ giúp giảm nguy cơ bị điện giật.
- Tránh tiếp xúc với các bề mặt được nối đất như đường ống, lò sưởi, bếp nướng và tủ lạnh.** Nguy cơ bị điện giật sẽ cao hơn nếu cơ thể bạn tiếp xúc trực tiếp với đất.
- Không để các dụng cụ điện cầm tay ngoài trời mưa hoặc ở nơi ẩm ướt.** Nước vào trong dụng cụ điện cầm tay sẽ làm tăng nguy cơ bị điện giật.
- Không dùng dây điện cho các mục đích khác. Tuyệt đối không sử dụng dây điện để mang, kéo hoặc rút phích cắm dụng cụ điện cầm tay. Để dây điện cách xa nguồn nhiệt, dầu mỡ, các cạnh sắc hoặc các bộ phận chuyển động.** Dây điện bị hỏng hoặc bị vướng sẽ làm tăng nguy cơ bị điện giật.
- Khi vận hành dụng cụ điện cầm tay ngoài trời, hãy sử dụng dây nối dài phù hợp để sử dụng ngoài trời.** Sử dụng dây điện phù hợp để sử dụng ngoài trời sẽ giúp giảm nguy cơ bị điện giật.
- Nếu bắt buộc phải vận hành dụng cụ điện cầm tay ở nơi ẩm ướt, hãy sử dụng nguồn được bảo vệ bởi thiết bị ngắt mạch tự động (RCD).** Sử dụng RCD giúp giảm nguy cơ bị điện giật.

#### 3) AN TOÀN CÁ NHÂN

- Hãy tập trung, chú ý vào những gì bạn đang làm và tỉnh táo khi vận hành dụng cụ điện cầm tay. Không sử dụng dụng cụ điện cầm tay khi bạn đang mệt hoặc chịu ảnh hưởng của rượu bia, ma túy hoặc chất kích thích.** Chỉ một khoảnh khắc mất tập trung trong khi vận hành dụng cụ điện cầm tay cũng có thể dẫn đến chấn thương cá nhân nghiêm trọng.
- Sử dụng thiết bị bảo hộ cá nhân. Luôn đeo kính bảo hộ.** Thiết bị bảo hộ như mặt nạ chống bụi, giày chống trượt, mũ cứng hoặc thiết bị bảo vệ tai - nếu được sử dụng ở những điều kiện phù hợp - sẽ giúp giảm các chấn thương cá nhân.
- Tránh vô tình bật máy. Đảm bảo rằng công tắc ở vị trí tắt trước khi nối với nguồn điện và/hoặc pin, khi cầm lên hoặc mang dụng cụ.** Việc cầm dụng cụ điện cầm tay khi ngón tay đặt vào công tắc hoặc sạc pin cho dụng cụ điện cầm tay khi công tắc đang bật có thể gây tai nạn.



- d) **Hãy tháo hết khóa điều chỉnh hoặc cờ lê trước khi bật dụng cụ điện cầm tay.** Việc không tháo cờ lê hoặc khóa điều chỉnh ra khỏi dụng cụ điện cầm tay có thể gây ra chấn thương cá nhân.
- e) **Không được với tay. Hãy đứng ở tư thế thích hợp và luôn giữ thăng bằng.** Điều đó giúp kiểm soát dụng cụ điện cầm tay tốt hơn trong các tình huống không thể lường trước.
- f) **Mặc quần áo phù hợp. Không mặc quần áo rộng hoặc đeo đồ trang sức. Giữ cho tóc, quần áo và găng tay tránh xa các bộ phận chuyển động.** Quần áo rộng, đồ trang sức hoặc tóc dài có thể bị vướng vào các bộ phận chuyển động.
- g) **Nếu các thiết bị được cung cấp để nối các phương tiện hút và gom bụi, hãy đảm bảo những thiết bị này được nối và sử dụng đúng cách.** Sử dụng thiết bị gom bụi có thể giảm các nguy cơ liên quan đến bụi.

**4) SỬ DỤNG VÀ BẢO QUẢN DỤNG CỤ ĐIỆN CẦM TAY**

- a) **Sử dụng dụng cụ điện cầm tay phù hợp. Sử dụng dụng cụ điện cầm tay phù hợp với mục đích của bạn.** Sử dụng dụng cụ điện cầm tay phù hợp sẽ giúp bạn làm việc hiệu quả hơn và an toàn hơn theo đúng thiết kế.
- b) **Không sử dụng dụng cụ điện cầm tay nếu công tắc không bật và tắt được.** Mọi dụng cụ điện cầm tay không điều khiển được bằng công tắc đều rất nguy hiểm và cần phải được sửa chữa.
- c) **Rút phích cắm dụng cụ điện cầm tay ra khỏi nguồn điện và/hoặc pin trước khi điều chỉnh, thay phụ kiện hoặc bảo quản dụng cụ điện cầm tay.** Các biện pháp an toàn phòng ngừa đó giúp giảm nguy cơ vô tình khởi động dụng cụ điện cầm tay.
- d) **Bảo quản các dụng cụ điện cầm tay không sử dụng xa tầm tay trẻ em và không cho phép những người không quen với dụng cụ điện cầm tay hoặc những hướng dẫn này vận hành dụng cụ điện cầm tay.** Dụng cụ điện cầm tay sẽ trở nên rất nguy hiểm khi được sử dụng bởi những người chưa được huấn luyện.
- e) **Bảo trì dụng cụ điện cầm tay. Kiểm tra các bộ phận di chuyển xem có bị lắp lệch hoặc kẹt không, các bộ phận có bị vỡ không và bất kỳ tình trạng nào khác có thể ảnh hưởng đến việc vận hành dụng cụ điện cầm tay. Nếu dụng cụ điện cầm tay bị hỏng, hãy sửa chữa trước khi sử dụng.** Rất nhiều tai nạn xảy ra do công tác bảo trì các dụng cụ điện cầm tay kém.

- f) **Giữ cho các dụng cụ cắt luôn sắc và sạch sẽ.** Các dụng cụ cắt được bảo trì đúng cách với các cạnh cắt sắc sẽ ít bị kẹt hơn và dễ điều khiển hơn.
- g) **Sử dụng dụng cụ điện cầm tay, các phụ kiện và mũi khoan, v.v...theo các hướng dẫn này, chú ý đến các điều kiện làm việc và công việc cần thực hiện.** Sử dụng dụng cụ điện cầm tay sai mục đích có thể gây nguy hiểm.

**5) SỬ DỤNG VÀ BẢO QUẢN DỤNG CỤ CHẠY BẰNG PIN**

- a) **Chỉ sạc lại pin bằng bộ sạc do nhà sản xuất quy định.** Bộ sạc - chỉ thích hợp cho một loại pin - có thể gây nguy cơ hỏa hoạn khi được sử dụng với loại pin khác.
- b) **Chỉ sử dụng dụng cụ điện cầm tay với các loại pin được chỉ định cụ thể.** Sử dụng các loại pin khác có thể gây nguy cơ chấn thương và hỏa hoạn.
- c) **Khi không sử dụng pin, để pin xa các vật dụng kim loại như kẹp giấy, tiền đồng, chìa khóa, đinh, vít hay các vật dụng kim loại nhỏ khác có thể tạo kết nối từ cực này sang cực khác.** Các cực của pin bị chạm mạch với nhau có thể khiến người vận hành bị bỏng hoặc gây hỏa hoạn.
- d) **Nếu lạm dụng pin, chất lỏng trong pin có thể chảy ra; tránh tiếp xúc với chất lỏng này. Nếu vô tình tiếp xúc với chất lỏng này, hãy rửa bằng nước sạch. Nếu chất lỏng dính vào mắt, hãy tìm kiếm trợ giúp y tế.** Chất lỏng chảy từ pin có thể gây kích ứng hoặc bỏng da.

**6) BẢO DƯỠNG**

- a) **Hãy để nhân viên bảo dưỡng có chuyên môn tiến hành bảo dưỡng dụng cụ điện cầm tay cho bạn, chỉ sử dụng các phụ tùng thay thế chính hãng.** Điều này giúp đảm bảo độ an toàn của dụng cụ điện cầm tay đó.

**Quy tắc an toàn cụ thể bổ sung cho máy khoan/máy vặn vít/máy khoan búa**

- **Đeo thiết bị bảo vệ tai khi làm việc với máy khoan búa.** Việc tiếp xúc với tiếng ồn có thể làm giảm thính lực.
- **Sử dụng tay cầm phụ, nếu được cung cấp kèm theo dụng cụ.** Việc mất khả năng kiểm soát có thể gây chấn thương cá nhân.
- **Chỉ cầm dụng cụ điện cầm tay ở phần bề mặt tay cầm cách điện khi thực hiện thao tác mà phụ kiện cắt có thể tiếp xúc với hệ thống dây**

**điện chim.** Phụ kiện cắt tiếp xúc với dây điện "có điện" có thể truyền điện cho các bộ phận kim loại hở của dụng cụ điện cầm tay và có thể khiến nhân viên vận hành bị điện giật.

- **Dùng kẹp hay áp dụng một biện pháp thực tế khác nhằm cố định và đỡ phối gia công trên bàn máy.** Giữ phối bằng tay hay dựa vào người bạn đều làm cho phối không vững và có thể dẫn tới mất kiểm soát.
- **Đeo kính bảo hộ hoặc các thiết bị bảo vệ mắt khác.** Việc đập và khoan có thể làm bắn ra các mảnh vụn. Những mảnh vụn này có thể gây ra những tổn thương lâu dài cho mắt.
- **Các phụ kiện và dụng cụ có thể nóng lên trong quá trình vận hành.** Đeo găng tay khi cầm chúng nếu bạn thực hiện các công việc sản sinh ra nhiệt chẳng hạn như khoan tường và khoan kim loại.
- **Không vận hành dụng cụ này trong khoảng thời gian dài.** Rung chấn từ hoạt động của khoan búa có thể có hại cho bàn tay và cánh tay bạn. Đeo găng tay để có thêm lớp bảo vệ và hạn chế tiếp xúc bằng cách thường xuyên nghỉ giải lao.
- **Các lỗ thông gió thường nằm trên lớp vỏ che các bộ phận di chuyển, bạn không nên chạm vào những lỗ thông gió này.** Quần áo rộng, đồ trang sức hoặc tóc dài có thể bị mắc vào các bộ phận chuyển động.

## Các nguy cơ khác

Các nguy cơ sau có thể phát sinh trong quá trình sử dụng máy khoan:

- Chấn thương do chạm vào các bộ phận quay hoặc các bộ phận nóng của dụng cụ.

Kể cả việc áp dụng các quy tắc an toàn liên quan và dùng các thiết bị an toàn cũng không thể tránh được một số nguy cơ khác. Những nguy cơ này gồm:

- Suy giảm thính lực.
- Nguy cơ bị kẹp tay khi thay phụ kiện.
- Nguy hại đến sức khoẻ do hít phải bụi khi khoan gỗ.
- Nguy cơ chấn thương cá nhân do các hạt bay vào người.
- Nguy cơ chấn thương cá nhân do sử dụng trong thời gian dài.

## Ký hiệu trên dụng cụ

Trên dụng cụ có các ký hiệu sau:



Đọc kỹ hướng dẫn sử dụng trước khi dùng.

## VỊ TRÍ MÃ NGÀY (HÌNH 1)

Mã ngày (j) - bao gồm cả năm sản xuất - được in trên mặt vỏ máy ở vị trí nổi giữa dụng cụ và pin.

Ví dụ:

2014 XX XX

Năm sản xuất

## Hướng dẫn an toàn quan trọng cho mọi bộ sạc pin

**GIỮ LẠI CÁC HƯỚNG DẪN NÀY:** Hướng dẫn sử dụng này bao gồm những hướng dẫn vận hành và hướng dẫn an toàn quan trọng dành cho bộ sạc pin DCB107.

- Trước khi sử dụng bộ sạc, hãy đọc tất cả các hướng dẫn và những ký hiệu cảnh báo trên bộ sạc, pin và sản phẩm chạy bằng pin.



**CẢNH BÁO:** Nguy cơ điện giật. Không để bất kỳ chất lỏng nào lọt vào bên trong bộ sạc. Điều này có thể gây điện giật.



**THẬN TRỌNG:** Nguy cơ gây bỏng. Để giảm nguy cơ bị chấn thương, chỉ sạc pin có thể sạc lại của Black & Decker. Việc sạc các loại pin khác có thể gây quá nhiệt và cháy nổ dẫn đến chấn thương cá nhân và hư hỏng tài sản.



**THẬN TRỌNG:** Phải giám sát để đảm bảo trẻ không nghịch thiết bị.

**LƯU Ý:** Trong một số trường hợp, khi bộ sạc vẫn được nối với nguồn điện, các điểm tiếp xúc sạc hở bên trong bộ sạc có thể bị chập mạch do chất lạ. Không để các chất lạ có tính dẫn điện chẳng hạn như, nhưng không giới hạn ở; bông thép, lá nhôm hoặc bất kỳ sự tích tụ nào của các hạt kim loại dính vào các hốc của bộ sạc. Luôn rút phích cắm bộ sạc ra khỏi nguồn điện khi không có pin trong hốc bộ sạc. Rút phích cắm trước khi vệ sinh bộ sạc.

- **KHÔNG sạc pin bằng bất kỳ bộ sạc nào không được khuyến dùng trong hướng dẫn sử dụng này.** Bộ sạc này được thiết kế riêng cho loại pin này.
- **Những bộ sạc này chỉ được thiết kế để sạc loại pin có thể sạc lại của DEWALT.** Sử dụng bộ sạc này cho các mục đích khác có thể dẫn đến nguy cơ hỏa hoạn, điện giật hoặc tử vong.
- **Không để bộ sạc dưới trời mưa hoặc tuyết.**
- **Khi ngắt kết nối bộ sạc, nên cầm tay ở phần phích cắm, không nên kéo bằng dây điện.** Điều này sẽ giúp giảm nguy cơ hỏng hóc phích cắm và dây điện.

- **Đảm bảo đặt dây điện gọn gàng để người khác không dẫm lên dây, vướng vào dây hoặc làm hỏng hoặc làm căng dây.**
- **Chỉ sử dụng dây nối dài trong trường hợp thực sự cần thiết.** Sử dụng dây nối dài không thích hợp có thể dẫn đến nguy cơ hỏa hoạn, điện giật hoặc tử vong.
- **Khi sử dụng bộ sạc ngoài trời, luôn chọn nơi khô ráo và sử dụng dây nối dài phù hợp để sử dụng ngoài trời sẽ giúp giảm nguy cơ bị điện giật.**
- **Không bít các khe thông gió trên bộ sạc. Các khe thông gió ở trên đỉnh và các bên của bộ sạc.** Đặt bộ sạc ở nơi cách xa mọi nguồn nhiệt.
- **Không sử dụng bộ sạc khi dây điện hoặc phích cắm bị hỏng** — thay ngay dây điện hoặc phích cắm hỏng.
- **Không sử dụng nếu bộ sạc bị va đập mạnh, bị rơi hoặc bị hỏng trong bất kỳ trường hợp nào.** Mang bộ sạc đến trung tâm dịch vụ được ủy quyền.
- **Không tháo bộ sạc; hãy mang bộ sạc đến trung tâm dịch vụ được ủy quyền khi cần bảo dưỡng hoặc sửa chữa.** Việc lắp lại không đúng có thể dẫn đến nguy cơ bị điện giật, hỏa hoạn hoặc tử vong.
- **Dây nguồn bị hỏng phải được thay thế ngay bởi nhà sản xuất, đại lý bảo dưỡng của nhà sản xuất hoặc người có tay nghề tương đương thực hiện để tránh nguy hiểm.**
- **Rút phích cắm bộ sạc ra khỏi ổ cắm trước khi thực hiện công việc vệ sinh.** Điều này sẽ giúp giảm nguy cơ bị điện giật. Tháo pin sẽ không giúp giảm nguy cơ này.
- **TUYỆT ĐỐI** không nối hai bộ sạc với nhau.
- **Bộ sạc được thiết kế để hoạt động bằng nguồn điện gia đình chuẩn 230 V. Không cắm bộ sạc vào nguồn điện có điện áp khác.** Điều này không áp dụng cho bộ sạc cho phương tiện giao thông.

**GIỮ LẠI CÁC HƯỚNG DẪN NÀY**

**Bộ sạc**

Bộ sạc DCB107 tương thích với các loại pin Li-ION 10,8 V, 14,4 V và 18 V (DCB121, DCB123, DCB125, DCB127, DCB140, DCB141, DCB142, DCB144, DCB145, DCB180, DCB181, DCB182, DCB183, DCB184 và DCB185).

Bộ sạc này không cần điều chỉnh và được thiết kế để người dùng có thể sử dụng một cách dễ dàng nhất.







**Quy trình sạc (hình 2)**

1. Cắm phích cắm bộ sạc vào ổ cắm 220-240V phù hợp trước khi lắp pin.
2. Lắp pin (g) vào bộ sạc, đảm bảo pin được lắp hoàn toàn vào bộ sạc. Đèn màu đỏ (đang sạc) nhấp nháy liên tục cho biết quá trình sạc đã bắt đầu.
3. Khi đèn màu đỏ SÁNG liên tục nghĩa là đã sạc xong. Pin đã được sạc đầy và có thể được sử dụng ngay hoặc để lại trong bộ sạc.

**LƯU Ý:** Để đảm bảo hiệu suất và tuổi thọ tối đa của pin Li-ION, hãy sạc đầy pin trước lần sử dụng đầu tiên.

**Quá trình sạc pin**

Tham khảo bảng dưới đây để biết thông tin về trạng thái sạc pin.

Trạng thái sạc—DCB107	
 đang sạc	— — — — — 
 đã sạc đầy	————— 
 ngừng sạc do quá nóng/lạnh	—————   

**NGỪNG SẠC DO QUÁ NÓNG/LẠNH (DCB107)**

Bộ sạc DCB107 được trang bị tính năng ngừng sạc khi quá nóng/lạnh. Khi bộ sạc phát hiện pin nóng, nó sẽ tự động ngừng sạc cho tới khi pin nguội.

Khi bộ sạc phát hiện pin lạnh, nó sẽ tự động ngừng sạc cho tới khi pin ấm lên.

Đèn màu đỏ sẽ tiếp tục nhấp nháy nhưng đèn báo màu vàng sẽ sáng trong suốt quá trình vận hành này. Khi pin đã nguội, đèn màu vàng sẽ tắt và bộ sạc tiếp tục quy trình sạc.

Các dụng cụ chạy bằng pin Li-ION XR được trang bị hệ thống bảo vệ điện tử, hệ thống này sẽ bảo vệ pin khỏi hiện tượng quá tải, quá nhiệt hoặc xả kiệt.

Dụng cụ sẽ tự động tắt nếu hệ thống bảo vệ điện tử hoạt động. Nếu điều này xảy ra, hãy đặt pin Li-ION vào trong bộ sạc cho tới khi pin được sạc đầy.

**Hướng dẫn an toàn quan trọng dành cho mọi loại pin**

Khi đặt hàng pin thay thế, hãy đảm bảo cung cấp số danh mục và điện áp pin.

Pin chưa được sạc đầy khi bạn lấy pin ra khỏi hộp. Trước khi sử dụng pin và bộ sạc, hãy đọc các hướng dẫn về an toàn dưới đây; sau đó, hãy tuân thủ quy trình sạc được phác thảo.

**ĐỌC MỌI HƯỚNG DẪN.**

- **Không sạc hoặc sử dụng pin trong các môi trường dễ cháy nổ, như các môi trường có**

**chất lỏng, khí ga hoặc bụi dễ cháy.** Lắp hoặc tháo pin ra khỏi bộ sạc có thể gây cháy bụi hoặc bốc khói.



**CẢNH BÁO:** Nguy cơ gây bỏng. Chất lỏng chảy ra từ pin có thể bắt lửa nếu tiếp xúc với tia lửa hoặc ngọn lửa.

- **Tuyệt đối không cố ấn pin vào bộ sạc. Không sửa đổi pin bằng bất kỳ cách nào để lắp vừa vào bộ sạc không tương thích vì pin có thể vỡ ra gây chấn thương cá nhân nghiêm trọng.**
- Chỉ sạc pin bằng bộ sạc DEWALT được chỉ định.
- **KHÔNG** vẩy nước vào pin hoặc nhúng pin vào nước hoặc các chất lỏng khác.
- **Không bảo quản hoặc sử dụng dụng cụ và pin ở nơi có nhiệt độ có khả năng lớn hơn hoặc bằng 40°C (105°F) (chẳng hạn như bên ngoài xưởng hoặc các công trình xây dựng bằng kim loại vào mùa hè).**
- Để đạt hiệu quả cao nhất, đảm bảo sạc đầy pin trước khi sử dụng.



**CẢNH BÁO:** Tuyệt đối không mở pin vì bất cứ lý do gì. Nếu vỏ pin bị nứt hoặc bị hỏng, không lắp pin vào bộ sạc. Không để lên, đánh rơi hoặc làm hỏng pin.

Không sử dụng pin hoặc bộ sạc bị va đập mạnh, bị rơi, bị dẫm lên hoặc bị làm hỏng bằng bất kỳ cách nào (ví dụ: bị móng tay chọc vào, bị búa đập vào, bị dẫm lên).

Điều này có thể gây điện giật hoặc tử vong. Nên trả lại pin bị hỏng cho trung tâm dịch vụ để tái chế.



**THẬN TRỌNG:** Khi không sử dụng, đặt nằm dụng cụ trên bề mặt chắc chắn để dụng cụ không bị trượt hoặc bị rơi.

Một số dụng cụ có pin lớn sẽ đứng thẳng được nhờ có pin nhưng dễ bị đổ.

## HƯỚNG DẪN AN TOÀN CỤ THỂ CHO PIN LITHIUM ION (Li-ION)

- **Không thiêu hủy pin ngay cả khi pin đã hỏng hoàn toàn hoặc bị mòn hết.** Pin có thể nổ khi bị thiêu hủy. Việc thiêu hủy pin sẽ sinh ra khói và các chất độc.
- **Nếu dung dịch của pin dính vào da của bạn, hãy rửa ngay bằng xà phòng có tính tẩy nhẹ và nước.** Nếu chất lỏng chảy ra từ pin dính vào mắt, hãy mở mắt và rửa mắt bằng nước sạch trong 15 phút hoặc cho tới khi hết bị kích ứng. Hãy tìm sự trợ giúp y tế nếu bạn tiếp xúc với chất điện phân của pin bao gồm hỗn hợp cacbonat hữu cơ lỏng và muối lithi.
- **Dung dịch chảy ra từ pin hỏng có thể gây ra kích ứng hô hấp.** Hãy hít thở không khí trong lành. Nếu không hết các triệu chứng, hãy tìm sự trợ giúp y tế.

## Pin

### LOẠI PIN

Các kiểu máy DCD734 tương thích với pin 14,4 v.

Các kiểu máy DCD771 và DCD776 tương thích với pin 18 v.

Bạn có thể sử dụng các pin DCB140, DCB142, DCB143, DCB144, DCB145, DCB180, DCB181, DCB182, DCB183, DCB184 hoặc DCB185 cho hai kiểu máy này. Tham khảo **Thông số kỹ thuật** để biết thêm thông tin.

## Khuyến cáo bảo quản

1. Nên bảo quản ở nơi mát mẻ và khô ráo, tránh ánh sáng mặt trời chiếu trực tiếp và không quá nóng hoặc quá lạnh. Để đạt hiệu suất tối ưu và kéo dài tuổi thọ của pin, bảo quản pin ở nhiệt độ trong phòng khi không sử dụng.
2. Khi bảo quản lâu, nên bảo quản pin đã sạc đầy ở nơi mát mẻ, khô ráo khi đã tháo ra khỏi bộ sạc để đạt hiệu quả tối ưu.

**LƯU Ý:** Không nên bảo quản pin khi đã hết điện. Cần sạc lại pin trước khi sử dụng.

## Ký hiệu trên bộ sạc và pin

Ngoài các biểu tượng được sử dụng trong hướng dẫn sử dụng này, trên bộ sạc và pin còn có các ký hiệu sau:



Đọc kỹ hướng dẫn sử dụng trước khi dùng.



Đang sạc.



Đã sạc đầy.



Ngừng sạc do quá nóng/quá lạnh.



Pin hoặc bộ sạc gặp sự cố.



Dây điện gặp sự cố.



Không kiểm tra bằng các vật dẫn điện.



Không sạc pin đã hỏng.



Chỉ sử dụng pin DeWALT cho dụng cụ.  
Các loại pin khác có thể gây cháy nổ, dẫn đến chấn thương cá nhân và hỏng dụng cụ.



Không để pin tiếp xúc với nước.

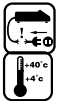

Lập tức thay dây nguồn đã hỏng.



Chỉ sạc khi nhiệt độ môi trường trong khoảng từ 4 °C đến 40 °C.



Thận trọng khi thải bỏ pin để bảo vệ môi trường.



Không thiêu hủy pin.



Sạc pin Li-ION.



Xem **Thông số kỹ thuật** để biết thời gian sạc.



Chỉ sử dụng trong nhà.

## Thiết bị trong hộp

Hộp sản phẩm bao gồm:

- 1 Máy khoan/máy vặn vít hoặc 1 máy khoan/máy vặn vít/máy khoan búa
- 1 Bộ sạc
- 1 Pin Li-ION (kiểu máy C1)
- 2 Pin Li-ION (kiểu máy C2)
- 3 Pin Li-ION (kiểu máy C3)
- 1 Vali phụ kiện
- 1 Hướng dẫn sử dụng

**LƯU Ý:** Các kiểu máy N không được cung cấp kèm pin, bộ sạc và vali phụ kiện.

- Kiểm tra dụng cụ, các bộ phận hoặc phụ kiện xem có bị hư hỏng do quá trình vận chuyển hay không.
- Dành thời gian đọc kỹ và hiểu rõ hướng dẫn sử dụng trước khi vận hành máy.

## Mô tả (hình 1)



**CẢNH BÁO:** Không sửa đổi dụng cụ điện cầm tay hay bất kỳ bộ phận nào của máy. Việc sửa đổi có thể làm hỏng dụng cụ hoặc gây chấn thương cá nhân.

- a. Công tắc khởi động
- b. Nút điều khiển thuận/ngược
- c. Vòng điều chỉnh mô men
- d. Bộ gạt số
- e. Đèn làm việc
- f. Đầu kẹp không chia
- g. Pin
- h. Nút nhả pin
- l. Tay cầm chính

## MỤC ĐÍCH SỬ DỤNG

Những máy khoan/máy vặn vít/máy khoan búa này được thiết kế để khoan, khoan đập và vặn vít một cách chuyên nghiệp.

**KHÔNG** sử dụng máy ở những nơi ẩm ướt hoặc có chất lỏng hoặc khí dễ cháy.

Những máy khoan/máy vặn vít/máy khoan búa này là dụng cụ điện cầm tay chuyên nghiệp.

**KHÔNG** để trẻ em tiếp xúc với dụng cụ. Cần phải giám sát khi người chưa có kinh nghiệm sử dụng dụng cụ này.

- Không cho phép những người (bao gồm cả trẻ em) bị suy giảm năng lực thể chất, trí tuệ hoặc cảm giác, hay người thiếu kinh nghiệm, kiến thức hoặc kỹ năng sử dụng dụng cụ điện cầm tay này, trừ khi có sự giám sát của người chịu trách nhiệm về vấn đề an toàn của họ. Tuyệt đối không để trẻ em một mình với sản phẩm này.

## An toàn điện

Động cơ điện được thiết kế để sử dụng tại một mức điện áp duy nhất. Luôn kiểm tra xem điện áp pin có bằng với điện áp trên tấm định mức hay không. Luôn đảm bảo điện áp của bộ sạc tương ứng với điện áp nguồn.



Bộ sạc DEWALT này được cách điện kép theo tiêu chuẩn IEC 60335; do đó, không cần dây nối đất.

Nếu dây cáp điện bị hỏng, phải thay bằng dây mới được cung cấp riêng tại các cơ sở bảo dưỡng của DEWALT.

## Sử dụng dây nối dài

Chỉ sử dụng dây nối dài khi thực sự cần thiết. Sử dụng dây nối dài được chấp thuận - phù hợp với dòng điện đầu vào của bộ sạc (xem **Thông số kỹ thuật**).

Kích thước dây dẫn tối thiểu là 1 mm<sup>2</sup>; chiều dài tối đa là 30 m.

Khi sử dụng trực quần dây điện, luôn trải hết dây ra.

## LẮP RÁP VÀ ĐIỀU CHỈNH



**CẢNH BÁO:** Để giảm nguy cơ chấn thương cá nhân nghiêm trọng, hãy tắt máy và tháo pin trước khi thực hiện bất kỳ điều chỉnh nào hoặc tháo/lắp các đồ gá hoặc phụ kiện. Việc bất ngờ khởi động cũng có thể gây chấn thương.



**CẢNH BÁO:** Chỉ sử dụng pin và bộ sạc DEWALT.

## Lắp và tháo pin ra khỏi dụng cụ (hình 2)



**CẢNH BÁO:** Luôn tháo pin trước khi lắp ráp và điều chỉnh. Luôn ngắt điện dụng cụ trước khi lắp hoặc tháo pin.

**LƯU Ý:** Để đạt hiệu quả cao nhất, đảm bảo sạc đầy pin.

### ĐỂ LẮP PIN VÀO TAY CẦM DỤNG CỤ

- Đặt pin (g) khớp vào rãnh trượt bên trong tay cầm của dụng cụ (hình 2).
- Trượt pin vào tay cầm cho tới khi pin được cố định chắc chắn trong dụng cụ và đảm bảo pin không rơi ra.

### ĐỂ THÁO PIN RA KHỎI DỤNG CỤ.

- Ấn nút nhả pin (h) rồi kéo pin một cách dứt khoát ra khỏi tay cầm dụng cụ.
- Lắp pin vào bộ sạc như được mô tả trong phần cung cấp nội dung về bộ sạc của hướng dẫn sử dụng dụng cụ này.

### ĐÈN BÁO ĐIỆN NĂNG CỦA PIN (HÌNH 2)

Một số pin DEWALT được trang bị đèn báo điện năng bao gồm ba đèn LED màu xanh cho biết mức điện còn lại của pin.

Để khởi động đèn báo điện năng, ấn và giữ nút đèn báo điện năng (k). Cả ba đèn LED màu xanh sẽ phát sáng cho biết mức điện còn lại. Khi mức điện của pin giảm xuống dưới giới hạn có thể sử dụng, đèn báo điện năng sẽ tắt và bạn cần phải sạc lại pin.

**LƯU Ý:** Đèn báo điện năng chỉ chỉ báo mức điện còn lại của pin. Đèn báo điện năng không chỉ báo chức năng của dụng cụ và có thể thay đổi tùy thuộc vào các bộ phận của sản phẩm, nhiệt độ và ứng dụng người dùng cuối cùng.

## Công tắc khởi động tốc độ biến thiên (hình 1)

Để bật dụng cụ, ấn công tắc khởi động (a). Để tắt dụng cụ, nhả công tắc khởi động. Dụng cụ này được trang bị phanh hãm. Đầu kẹp sẽ dừng lại ngay sau khi bạn nhả hết công tắc khởi động.

**LƯU Ý:** Không nên sử dụng dụng cụ liên tục trong phạm vi tốc độ biến thiên. Cách sử dụng này có thể làm hỏng công tắc và nên được tránh.

## Nút điều khiển thuận/ngịch (hình 1)

Nút điều khiển thuận/ngịch (b) quyết định hướng của dụng cụ đồng thời có chức năng như một nút khóa.

Để chọn quay theo chiều thuận, nhả công tắc khởi động rồi ấn nút điều khiển thuận/ngịch ở bên phải của dụng cụ.

Để chọn quay theo chiều nghịch, ấn nút điều khiển thuận/ngịch ở bên trái của dụng cụ.

Vị trí ở giữa của nút điều khiển sẽ khóa dụng cụ ở vị trí tắt. Khi thay đổi vị trí của nút điều khiển, phải đảm bảo đã nhả công tắc khởi động.

**LƯU Ý:** Vận hành dụng cụ lần đầu tiên sau khi đổi hướng, bạn có thể nghe thấy tiếng lách cách khi khởi động. Đây là hiện tượng bình thường và không có gì đáng lo ngại.

## Vòng điều chỉnh mô men (hình 1)

Dụng cụ này được trang bị cơ cấu máy vận vít mô men có thể điều chỉnh được để vận và tháo bằng hàng loạt hình dáng cũng như kích thước đầu cặp và một số kiểu máy được trang bị cơ cấu máy khoan búa để khoan tường. Xung quanh vòng điều chỉnh (c) là các số, ký hiệu mũi khoan và trên một số kiểu máy còn có ký hiệu búa. Những số này được sử dụng để điều chỉnh khớp ly hợp giúp xác định giới hạn mô men. Số trên vòng điều chỉnh càng cao, mô men càng lớn và đầu cặp - có thể được điều chỉnh - càng rộng. Để chọn bất kỳ số nào, quay vòng điều chỉnh cho tới khi số mong muốn thẳng với mũi tên.

## Hộp số hai tốc độ (hình 1)

Tính năng hai tốc độ của máy khoan/máy vận vít/máy khoan búa này cho phép bạn chuyển số để vận hành linh hoạt hơn.

- Để chọn tốc độ 1 (cài đặt mô men cao), tắt dụng cụ và chờ dụng cụ dừng lại. Trượt bộ gạt số (d) về phía trước (về phía đầu kẹp).
- Để chọn tốc độ 2 (cài đặt mô men thấp), tắt dụng cụ và chờ dụng cụ dừng lại. Trượt bộ gạt số về phía sau (ra xa đầu kẹp).

**LƯU Ý:** Không chuyển số khi dụng cụ đang chạy. Luôn chờ máy khoan dừng hẳn rồi mới chuyển số. Nếu bạn gặp khó khăn khi chuyển số, đảm bảo bộ gạt số hai tốc độ được đẩy hết về phía trước hoặc phía sau.

### Đèn làm việc (hình 1)

Đèn làm việc (e) nằm ngay phía trên công tắc khởi động (a). Đèn làm việc được kích hoạt khi bạn ấn công tắc khởi động. Khi bạn nhả công tắc khởi động, đèn làm việc sẽ tiếp tục phát sáng trong tối đa 20 giây.

**LƯU Ý:** Đèn làm việc được sử dụng để chiếu sáng trực tiếp bề mặt phải và không thực hiện chức năng của đèn pin.

### Đầu kẹp một khớp không khóa (hình 7–9)



**CẢNH BÁO:** Không xiết chặt mũi khoan (hoặc bất kỳ phụ kiện nào khác) bằng cách kẹp phần mặt trước của đầu kẹp và bật dụng cụ. Việc này có thể khiến đầu kẹp bị hỏng và gây chấn thương cá nhân. Luôn khóa công tắc khởi động và rút phích cắm dụng cụ ra khỏi nguồn điện khi thay phụ kiện.



**CẢNH BÁO:** Luôn đảm bảo cố định mũi khoan trước khi bật dụng cụ. Mũi khoan lỏng có thể bắn ra khỏi dụng cụ gây chấn thương cá nhân.

Dụng cụ này được trang bị đầu kẹp không khóa (f) có khớp quay để quay đầu kẹp bằng một tay. Để lắp mũi khoan hoặc phụ kiện khác, làm theo các bước sau.

1. Tắt dụng cụ rồi rút phích cắm dụng cụ ra khỏi nguồn điện.
2. Một tay cầm khớp nối màu đen của đầu kẹp, tay còn lại cố định dụng cụ. Quay khớp nối ngược chiều kim đồng hồ ra đủ xa để có thể lắp vừa phụ kiện mong muốn.
3. Một tay lắp phụ kiện khoảng 19 mm (3/4SDSq) vào đầu kẹp rồi vặn chặt bằng cách quay khớp nối đầu kẹp theo chiều kim đồng hồ trong khi tay còn lại vẫn giữ dụng cụ. Dụng cụ này được trang bị cơ cấu khóa trực tự động. Cơ cấu này cho phép bạn mở và đóng đầu kẹp bằng một tay.

Đảm bảo vặn chặt đầu kẹp bằng cách cầm một tay vào khớp nối đầu kẹp và tay còn lại cầm vào dụng cụ để vặn thật chặt.

Để tháo phụ kiện, lặp lại bước 1 và 2 nêu trên.

## VẬN HÀNH

### Hướng dẫn sử dụng



**CẢNH BÁO:** Luôn xem kỹ hướng dẫn an toàn và quy tắc được áp dụng.



**CẢNH BÁO:** Để giảm nguy cơ chấn thương cá nhân nghiêm trọng, hãy tắt máy và tháo pin trước khi thực hiện bất kỳ điều chỉnh nào hoặc tháo/lắp các đồ gá hoặc phụ kiện. Việc bất ngờ khởi động cũng có thể gây chấn thương.

### Vị trí tay phù hợp (hình 3)



**CẢNH BÁO:** Để giảm nguy cơ chấn thương cá nhân nghiêm trọng, **LUÔN** để tay ở vị trí phù hợp như được mô tả trong hình vẽ.



**CẢNH BÁO:** Để giảm nguy cơ chấn thương cá nhân nghiêm trọng, **LUÔN** giữ chặt tay để tránh trường hợp bị giật lại đột ngột.

Vị trí tay phù hợp là một tay cầm vào phần trên cùng của máy khoan như được mô tả trong hình vẽ, tay còn lại cầm vào tay cầm chính (i).

### Vận hành máy vặn vít (hình 4)

1. Chọn tốc độ/giới hạn mô men mong muốn bằng cách sử dụng công tắc chọn số hai tốc độ khớp với tốc độ và mô men của chế độ vận hành dự kiến.
2. Xoay vòng điều chỉnh mô men (c) tới vị trí mong muốn. Các số thấp hơn cho biết cài đặt mô men thấp hơn; số cao hơn cho biết cài đặt mô men cao hơn.
3. Lắp phụ kiện đầu cặp mong muốn vào đầu kẹp như khi lắp mũi khoan.
4. Làm thử vài lần với mảnh phế liệu hoặc trên những khu vực không nhìn thấy để xác định vị trí phù hợp của ống kẹp.
5. Luôn cài đặt mô men thấp hơn khi bắt đầu, sau đó chỉnh lên cài đặt mô men cao hơn để tránh làm hỏng phôi gia công hoặc đầu cặp.

### Vận hành máy khoan (hình 5)



**CẢNH BÁO:** Để giảm nguy cơ chấn thương cá nhân nghiêm trọng, hãy tắt máy và rút phích cắm ra khỏi nguồn điện trước khi thực hiện bất kỳ điều chỉnh nào hoặc tháo/lắp các đồ gá hoặc phụ kiện.



**CẢNH BÁO: Để giảm nguy cơ chấn thương cá nhân, LUÔN đảm bảo phải gia công đã được neo và kẹp chặt. Nếu khoan vật liệu mỏng, sử dụng khối gỗ "kê" để hạn chế làm hỏng vật liệu.**

1. Xoay vòng điều chỉnh (c) tới ký hiệu máy khoan.
2. Chọn tốc độ/giới hạn mô men mong muốn bằng cách sử dụng bộ gạt số khớp với tốc độ và mô men của chế độ vận hành dự kiến.
3. Khi khoan GỖ, dùng mũi khoan xoắn, mũi khoan hình mai, mũi khoan xoay hoặc cưa vòng. Khi khoan KIM LOẠI, dùng mũi khoan xoắn bằng thép có tốc độ cao hoặc cưa vòng. Khi khoan kim loại phải dùng một loại dầu bôi trơn cắt. Những trường hợp ngoại lệ như gang, đồng thau, những chất liệu này nên được khoan khô.
4. Luôn đặt áp lực lên trên một đường thẳng với mũi khoan. Tác dụng đủ lực để cố định máy khoan nhưng không được ấn mạnh tới mức khiến động cơ ngừng hoạt động hoặc làm hỏng mũi khoan.
5. Dùng cả hai tay giữ chặt máy để kiểm soát lực xoắn của máy khoan. Nếu kiểu máy này không được trang bị tay cầm bên, một tay giữa tay cầm của máy khoan và tay còn lại giữ vào pin.



**THẬN TRỌNG: Khoan có thể ngừng hoạt động nếu bị quá tải gây ra hiện tượng xoắn đột ngột. Luôn chuẩn bị khắc phục hiện tượng dừng đột ngột. Giữ chặt máy khoan để kiểm soát lực xoắn và tránh chấn thương.**

6. **NẾU KHOAN NGỪNG HOẠT ĐỘNG**, thường là do máy bị quá tải hoặc do sử dụng không đúng cách. **NHÀ CÔNG TÁC KHỞI ĐỘNG NGAY LẬP TỨC**, tháo mũi khoan ra khỏi phôi và xác định nguyên nhân khiến máy ngừng hoạt động. **KHÔNG CÓ BẬT TẮT CÔNG TÁC KHỞI ĐỘNG ĐỂ KHỞI ĐỘNG LẠI KHOAN ĐÃ BỊ NGỪNG HOẠT ĐỘNG – VIỆC NÀY CÓ THỂ LÀM HỎNG KHOAN.**
7. Để giảm thiểu tình trạng chết máy hoặc đâm xuyên qua vật liệu, giảm lực trên khoan và nới lỏng mũi khoan trên phần đoạn cuối của lỗ khoan.
8. Khi rút mũi khoan ra khỏi lỗ khoan, giữ cho động cơ tiếp tục chạy. Điều này sẽ giúp tránh nguy cơ bị kẹt.
9. Với máy khoan có tốc độ biến thiên, không cần đặt mũi khoan vào giữa điểm cần khoan. Khi bắt đầu với lỗ khoan, sử dụng tốc độ thấp và tăng tốc bằng cách ấn công tắc khởi động mạnh hơn khi lỗ khoan đủ sâu để khoan mà không làm mũi khoan bật ra.

## DCD776

1. Xoay vòng điều chỉnh (c) tới ký hiệu máy khoan búa.
2. Chọn cài đặt tốc độ cao bằng cách trượt công tắc chọn tốc độ về phía sau (ra xa đầu kẹp).

**QUAN TRỌNG:** Chỉ sử dụng mũi khoan có đầu cacbua hoặc mũi khoan tung.

3. Dùng vừa đủ lực khi khoan trên máy khoan búa để giữ cho máy khởi này lên quá nhiều hoặc "bắn" ra khỏi mũi khoan. Dùng quá nhiều lực sẽ làm giảm tốc độ khoan, gây hiện tượng quá nhiệt và tốc độ khoan chậm hơn.
4. Khoan thẳng, giữ mũi khoan tại góc làm việc phù hợp. Không tác dụng lực ngang lên mũi khoan khi khoan vì điều này sẽ gây ra tắc nghẽn rãnh mũi khoan và làm giảm tốc độ khoan.
5. Khi khoan lỗ sâu, nếu tốc độ máy khoan búa bắt đầu giảm, kéo một phần mũi khoan ra khỏi lỗ khi dụng cụ vẫn chạy để giúp loại bỏ vụn sắt ra khỏi lỗ.

**LƯU Ý:** Dòng bụi nhẵn, đều bay ra từ lỗ cho thấy tốc độ khoan phù hợp.

## BẢO TRÌ

Dụng cụ điện cầm tay DEWALT được thiết kế để vận hành trong thời gian dài và ít phải bảo trì nhất. Dụng cụ vận hành liên tục theo ý muốn tùy thuộc vào việc bảo quản dụng cụ đúng cách và vệ sinh thường xuyên.



**CẢNH BÁO: Để giảm nguy cơ chấn thương cá nhân nghiêm trọng, hãy tắt máy và tháo pin trước khi thực hiện bất kỳ điều chỉnh nào hoặc tháo/lắp các đồ gá hoặc phụ kiện. Việc bất ngờ khởi động cũng có thể gây chấn thương.**

Bộ sạc và pin không thể bảo dưỡng. Dụng cụ không bao gồm các bộ phận có thể bảo dưỡng.



## Tra dầu

Dụng cụ điện cầm tay này không cần tra thêm dầu.



## Vệ sinh



**CẢNH BÁO:** Thường xuyên thổi bụi bẩn khỏi vỏ dụng cụ khi thấy bám bụi xung quanh các lỗ thông gió. Đeo kính bảo hộ và mặt nạ chống bụi được phê duyệt khi thực hiện quy trình này.

## Vận hành máy khoan búa (hình 6)





**CẢNH BÁO:** Tuyệt đối không sử dụng các dung môi và hóa chất mạnh để vệ sinh các bộ phận không làm bằng kim loại của dụng cụ. Các hóa chất này có thể làm tổn hại đến các nguyên vật liệu sử dụng trong các bộ phận này. Chỉ sử dụng khăn được làm ẩm bằng nước và xà phòng có tính tẩy nhẹ. Tuyệt đối không để chất lỏng lọt vào bên trong dụng cụ; không nhúng các bộ phận của dụng cụ vào chất lỏng.

## HƯỚNG DẪN VỆ SINH BỘ SẠC



**CẢNH BÁO:** Nguy cơ điện giật. Rút phích cắm bộ sạc ra khỏi ổ cắm điện xoay chiều trước khi thực hiện công việc vệ sinh. Có thể loại bỏ bụi bẩn và dầu nhờn khỏi vỏ ngoài của bộ sạc bằng cách sử dụng vải hoặc bàn chải mềm phi kim. Không sử dụng nước hoặc bất kỳ dung dịch vệ sinh nào.

## Các phụ kiện tùy chọn



**CẢNH BÁO:** Do các phụ kiện, không phải loại phụ kiện do DEWALT, cung cấp, chưa được kiểm nghiệm với sản phẩm này; nên việc sử dụng các phụ kiện đó với sản phẩm này có thể gây nguy hiểm. Để giảm nguy cơ chấn thương, chỉ được sử dụng các phụ kiện do DEWALT khuyến nghị cho sản phẩm này.

Hỏi ý kiến đại lý bạn để biết thêm thông tin về các phụ kiện phù hợp.

## Bảo vệ môi trường



Thu gom riêng. Không được thải bỏ sản phẩm này chung với rác thải gia đình thông thường.

Nếu bạn cần thay thế sản phẩm DEWALT của mình hoặc bạn không sử dụng nó trong tương lai nữa, đừng thải bỏ cùng với rác thải gia đình. Sản phẩm này phải được thu gom riêng.



Thu gom riêng sản phẩm và bao bì đóng gói đã qua sử dụng sẽ cho phép tái chế và tái sử dụng vật liệu. Tái sử dụng vật liệu tái chế giúp ngăn chặn ô nhiễm môi trường và giảm nhu cầu vật liệu thô.

Luật lệ địa phương có thể quy định việc thu gom riêng các sản phẩm điện gia dụng tại các bãi rác thải đô thị hoặc bởi những người bán lẻ khi bạn mua sản phẩm mới.

DEWALT cung cấp nơi thu gom và tái chế các sản phẩm của DEWALT khi các sản phẩm này đã hết hạn

sử dụng. Để sử dụng dịch vụ này, vui lòng trả lại sản phẩm cho đại lý sửa chữa được ủy quyền, nơi thay mặt công ty chúng tôi thu gom các sản phẩm này.

Bạn có thể kiểm tra vị trí của đại lý sửa chữa được ủy quyền gần nhất bằng cách liên hệ với văn phòng DEWALT tại nơi bạn sống theo địa chỉ cung cấp trong tài liệu hướng dẫn này. Ngoài ra, chúng tôi cũng cung cấp danh sách các đại lý sửa chữa được ủy quyền của DEWALT và toàn bộ thông tin chi tiết về dịch vụ hậu mãi và các thông tin liên hệ tại trang web: [www.2helpU.com](http://www.2helpU.com).



## Pin có thể sạc lại

Phải sạc lại pin có tuổi thọ cao này khi pin không đủ điện để thực hiện những công việc mà trước đó đã thực hiện một cách dễ dàng. Nếu tuổi thọ pin đã hết, hãy cẩn trọng khi thải bỏ pin để bảo vệ môi trường:

- Xả hết pin, sau đó tháo pin ra khỏi dụng cụ.
- Pin Li-ION có thể tái chế được. Hãy mang chúng đến đại lý hoặc trạm tái chế tại gần nhất. Pin được thu gom sẽ được tái chế hoặc thải bỏ theo cách phù hợp.





